



Fulfilling Real Expectations.



90  
1933 - 2023  
U

European Company. Since 1933.





# HERZ

/ HERZ sanitary tapware is manufactured by using technologically elaborate processing devices at a modern production and development centre in Šmartno pri Litiji. More than 90 years of experience are the source of our knowledge and inspiration for creating and developing high-quality sanitary tapware, which is also confirmed by all major European Certificates.

/ HERZ Sanitärarmaturen werden in unserem modernen Produktions- und Entwicklungszentrum in Šmartno pri Litiji, Slowenien hergestellt. Modernste Technologien in Verbindung mit 90 Jahren Erfahrung sind die Elemente unserer Inspiration zur Entwicklung hochwertiger Sanitärarmaturen. Unser hoher Qualitätsanspruch wird durch alle relevanten europäischen Zertifikate bestätigt.

## MISSION

To recognise living trends in the environment in which we operate and develop products which are technologically advanced and technically elaborate, but yet simple and practical to use, as well as visually elaborate in detail, based on recognising the demands of users and the market.

## MISSION

Moderne Küchen- und Badarmaturen sind längst mehr als nur funktionale Wasserhähne. Unsere Produkte orientieren sich an den Bedürfnissen, Wünschen und Erwartungen unserer Kunden. Auf dieser Basis entwickeln wir Sanitärarmaturen, die technologisch fortschrittlich, technisch durchdacht, modern im Design und praktisch in der Anwendung sind.

/ Our sanitary fittings match all required European standards; SIST EN200, SIST EN246, SIST EN248, SIST EN817, SIST EN1112 and SIST EN1113.

/ Unsere Sanitärarmaturen erfüllen alle erforderlichen europäischen Normen: SIST EN200, SIST EN246, SIST EN248, SIST EN817, SIST EN1112 und SIST EN1113.

# TAPWARE ARMATUREN



/ HERZ sanitary tapware is present in 75 countries worldwide. New investments, technology and knowledge have enabled the growth of production and development since 1933. In the light of users' wishes, new trends and the increasingly demanding taste of our customers, the quality level of the HERZ sanitary tapware is constantly improving and getting close to the leading companies in this sector.



## VISION

HERZ would like to become one of the leading, internationally renowned manufacturers of sanitary tapware, distinguished by its technological perfection, practicality, environmental friendliness, top-notch quality and modern design at reasonable prices. We strive to recognise the trends and needs on markets in time, as well as develop them and use them in creating products with a recognisable visual concept and their own story.

## VISION

Unser Ziel ist es, einer der führenden, international renommierten Sanitärarmaturenhersteller zu werden, der sich durch technologische Perfektion, Praktikabilität, Umweltfreundlichkeit, erstklassige Qualität und modernes Design zu günstigen Preisen auszeichnet. Wir sind bestrebt, Trends und Marktanforderungen rechtzeitig zu erkennen, umzusetzen und weiter zu entwickeln, um einzigartige Produkte mit einem klar erkennbaren visuellen Konzept und individuellen Vorteilen zu kreieren.

/ HERZ Sanitärarmaturen werden aktuell in 75 Ländern vertrieben. Neue Investitionen, der Einsatz modernster Technologien und die Dynamik im Bereich Forschung & Entwicklung sind die Bausteine unseres Unternehmenserfolgs seit 1933. Kundenwünsche, Designansprüche und neue Trends beeinflussen maßgeblich unser Streben nach kontinuierlicher Steigerung des Qualitätsniveaus unserer Produkte. Unser Anspruch ist es, zu den Marktführern in diesem Segment zu gehören.



/ Reduce your water consumption and save with use of water saving set HERZ. The Eco set contains two ECO aerators that enable water flow of 6 l/minute and water flow regulator for the shower that enables the water flow of 9 l/minute. Eco set is possible to use at all lines of sanitary mixers HERZ.

/ Reduzieren Sie Ihren Wasserverbrauch und sparen Sie mit der Nutzung des HERZ-Wassersparsets. Das Eco-Set enthält zwei ECO-Perlatoren mit einem Wasserdurchfluss von 6 l/min, und einen Wasserdurchflussregler für die Dusche mit einem Wasserdurchfluss von 9 l/min. Das Eco-Set kann bei allen HERZ-Sanitärarmaturen verwendet werden.



# ECOLOGY

# ÖKOLOGIE

## **ENVIRONMENTAL AWARENESS AND CONCERN**

A prudent consumption of sources and energy products, environmentally friendly production methods, as well as environmental concern, are a part of our social responsibility and awareness.

The use of environmentally friendly packaging and promotion materials represents only a part of our environmental awareness. This is followed by environmentally friendly production procedures: A modern galvanization line, wastewater management and re-use of waste materials.

In the spirit of environmental concern, we also place great emphasis on safety and energy conservation. Our products are, thus, characterised by the deliberate approach to water consumption savings, energy efficiency and, consequently, conservation of natural resources.

## **NACHHALTIGKEIT UND UMWELTSCHUTZ**

Ein nachhaltiger Umgang mit Ressourcen und Energie, umweltfreundliche Produktionsmethoden sowie Umweltschutz sind Teil unserer gesellschaftlichen Verantwortung.

Umweltschonende Produktionsverfahren, eine moderne Galvanisierung, Abwassermanagement und die Wiederverwertung von Abfallstoffen sowie der Einsatz umweltfreundlicher Verpackungs- und Werbematerialien sind für uns selbstverständlich und Teil unseres gelebten Verantwortungsbewusstseins.

Im Sinne des Umweltschutzes legen wir auch großen Wert auf Sicherheit und Energieeinsparung. Unsere Produkte zeichnen sich durch bewussten und effizienten Umgang mit Wasser und Energie und damit auch durch die Schonung der natürlichen Ressourcen aus.

# INDEX

<b>BATHROOM</b> <b>BADEZIMMER</b>	10
Design series	12
Classic series	70
<b>KITCHEN</b> <b>KÜCHE</b>	92
Design series	94
Classic series	124
<b>CONCEALED MIXERS</b> <b>UNTERPUTZ</b>	140
<b>SHOWERS</b> <b>DUSCHEN</b>	150
<b>ACCESSORIES</b> <b>ZUBEHÖR</b>	188





# LEGEND

# LEGENDE



only mixer  
nur Armatur



only mixer  
nur Armatur



with waste  
Abfluss



angle valves  
Eckventile



with waste, angle valves  
Abfluss, Eckventile



with waste, siphon, angle valves  
Abfluss, Siphon, Eckventile



low pressure version  
Niederdruckversion



angle valves, low pressure version  
Eckventile, Niederdruckversion



shower head, hose and wall holder  
Brausekopf, Brauseschlauch und  
Wandhalter



shower head, hose and shower rail  
Brausekopf, Brauseschlauch und  
Brausestange



head shower  
Kopfbrause



mixer with different spout lengths  
armaturen mit unterschiedlichen  
Auslauflängen



mixer with eco cartridge  
armaturen mit Ökopatrone



mixer with medical handle  
armatura s liječničkom ručicom



Concealed shower mixer  
Unterputz-Duscharmatur



Concealed shower mixer  
Unterputz-Duscharmatur



Rosette and handle  
Sichtteil



power supply  
Stromversorgung



power supply  
Stromversorgung

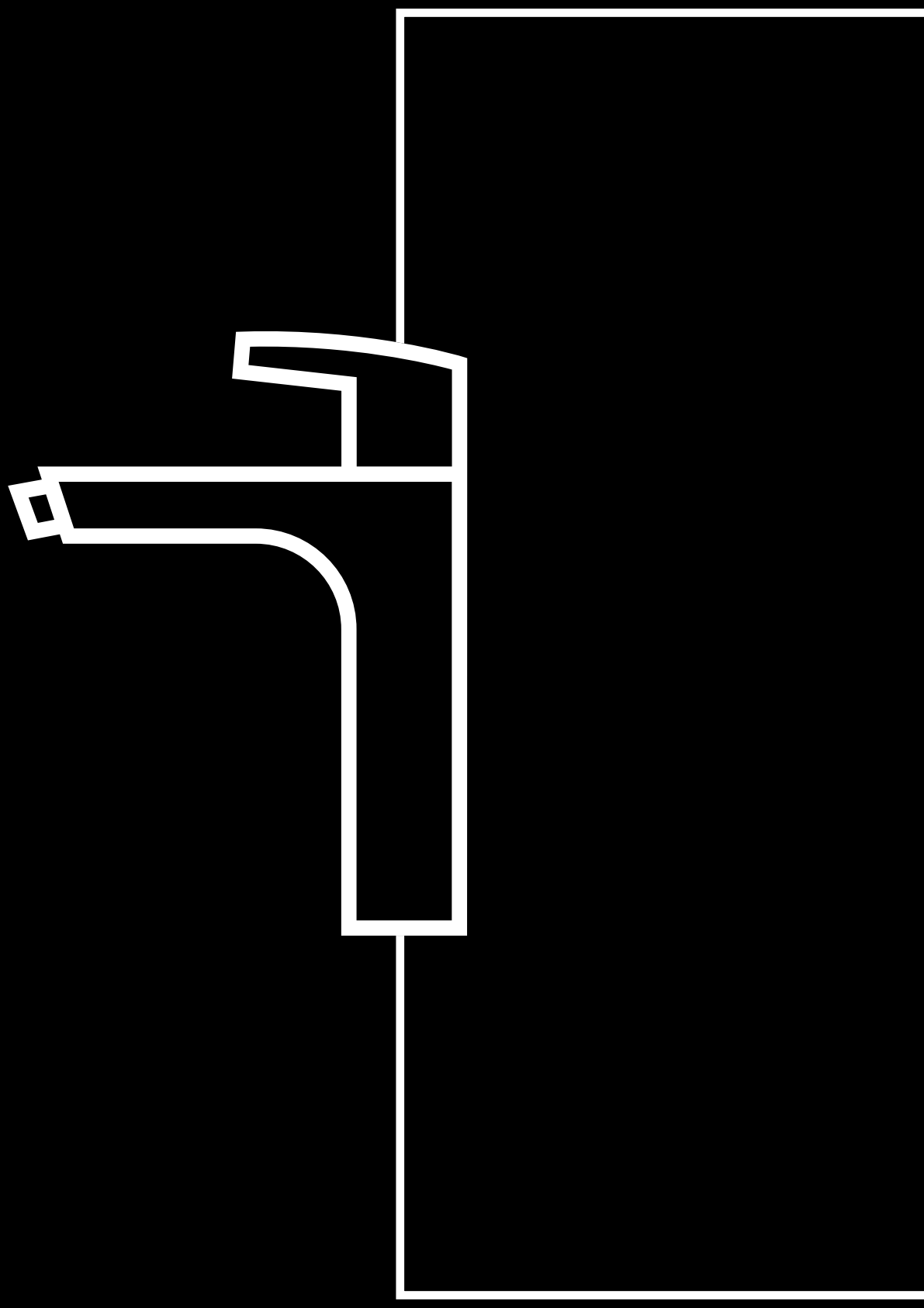

BATHROOM  
BADEZIMMER



# DESIGN SERIES

BATHROOM  
BADEZIMMER

# DESIGN SERIES



/ The Elite bathroom tapware stands out from the formal monotony with its elegant shape. In spite of the basic straight lines, the tapware, with its rounded soft transitions, complies with the strict architecture in the bathroom, as well as classic soft shapes. For an even more minimalist and exclusive appearance, you can choose the Elite flush-mounted washbasin tapware, as well as a rosette and handle for the built-in shower battery.

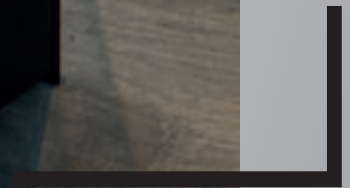
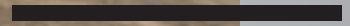
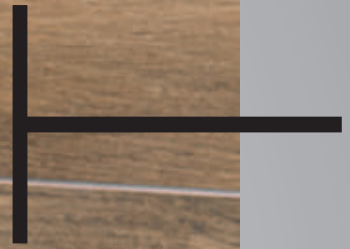

/ Bringen Sie Schwung in Ihre Wellness-Oase: mit der eleganten Form der Elite-Badarmaturen, die gekonnt Geradlinigkeit mit weichen, fließenden Übergängen verbindet –für die Fortsetzung strenger Linienführung aber auch bei der Verwendung von klassisch weichen Stilelementen in der Badarchitektur. Für eine noch minimalistischere und exklusivere Optik: Waschtischarmatur und Brausebatterie Elite mit Wandabdeckung und Bedienhebel für den Unterputz-Einbau oder die Vorwandinstallation.





## Elite e12B

Basin mixer;  
higher version  
Waschbeckenarmatur;  
Version "erhöht"



00089B



/ Bath/shower mixers and shower mixers with shower set include water flow regulator that enables the water flow of 6 l/minute.

/ Bad / Dusche Armaturen und Duscharmatur mit Duschgarnitur enthalten Wassermengenregler, die einen Wasserdurchfluss von 6 l/min ermöglichen.





## Elite e11B

Basin mixer  
Waschbeckenarmatur



00088B

17

## Elite e50B

Bidet mixer  
Bidetarmatur



00588B



## Elite e80B

Concealed basin mixer  
Unterputz-Waschtischbatterie



00080B



Note: 12705B – extension option  
Anmerkung: 12705B - Verlängerungsoption



## Elite e30B

Bath/shower mixer  
Wannen-/Duscharmatur



00373B

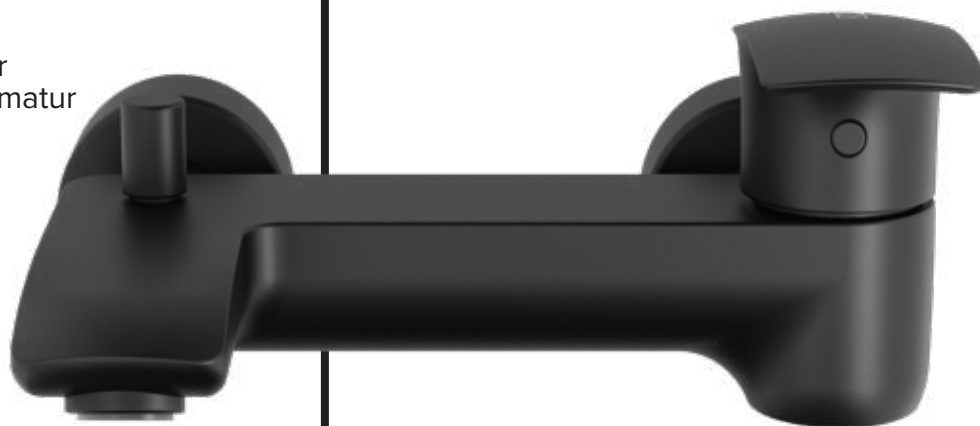

## Elite e40B

Shower mixer  
Duscharmatur



00485B





## Elite e12

Basin mixer;  
higher version  
Waschbeckenarmatur;  
Version "erhöht"



00089



00079



00090

/ Bath/shower mixers and shower mixers with shower set include water flow regulator that enables the water flow of 6 l/minute.

/ Bad / Dusche Armaturen und Duscharmatur mit Duschgarnitur enthalten Wassermengenregler, die einen Wasserdurchfluss von 6 l/min ermöglichen.





## Elite e11

Basin mixer\*  
Waschbeckenarmatur\*



00088



00086



00087



00085

\* Also available: base for basin/bidet mixer, product no. 19219.  
\* Auch erhältlich: Sockel für Waschtischbatterie, Artikelnummer 19219.

## Elite e50

Bidet mixer\*  
Bidetarmatur\*



00588



00586

\* Also available: base for basin/bidet mixer, product no. 19219.  
\* Auch erhältlich: Sockel für Waschtischbatterie, Artikelnummer 19219.

## Elite e80

Concealed basin mixer  
Unterputz-Waschtischbatterie



00080



Note: 12705 - extension option  
Anmerkung: 12705 - Verlängerungsoption



## Elite e30

Bath/shower mixer  
Wannen-/  
Duscharmatur

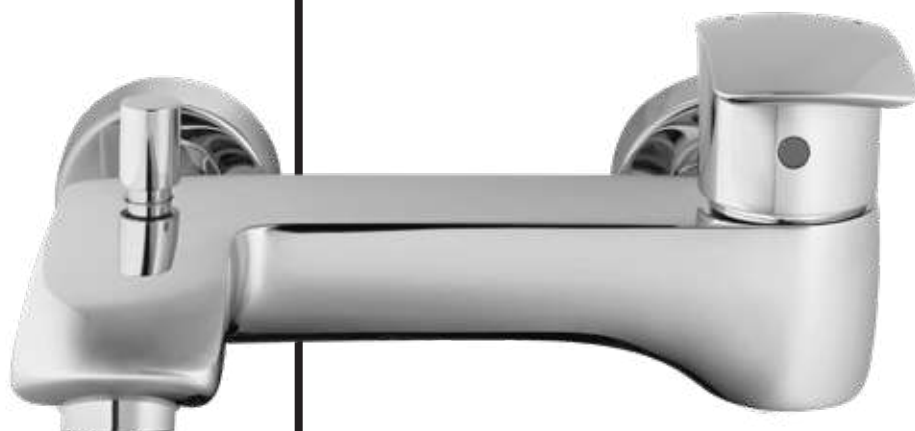

00373



00374



00375

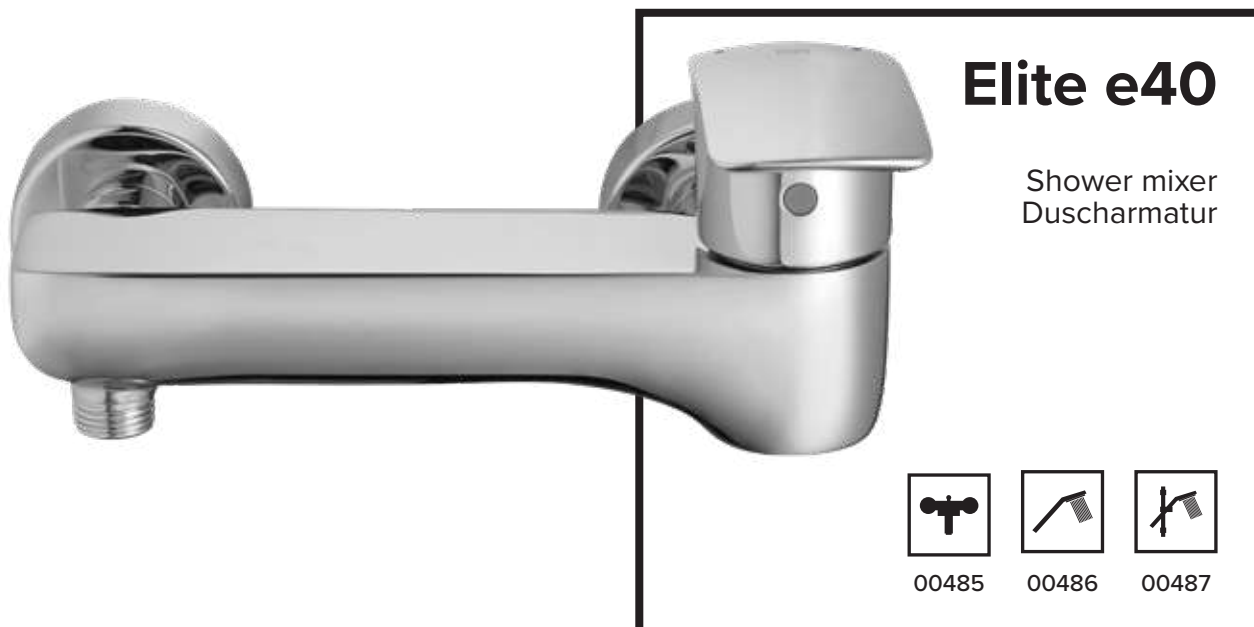

## Elite e40

Shower mixer  
Duscharmatur



00485



00486



00487

# DESIGN SERIES



/ The SQ line is special due to its uniqueness, as this is the only bathroom tapware series characterised by completely square shapes. The top-notch design, which fits excellently into bathrooms with modern design and emphasis on details, is hidden in pure straight lines behind their apparent strictness. Top quality combined with usefulness and the elaborate image is what makes the SQ line unique.





/ Pure Geradlinigkeit mit scheinbarer Strenge: kantige Formen sind das Markenzeichen der SQ-Linie, die vor allem die Designansprüche moderner Bäder perfekt widerspiegeln. Die Kombination höchster Qualitätsansprüche, optimaler Handhabung und durchdachter Formgebung machen die SQ-Kollektion dabei so einzigartig.



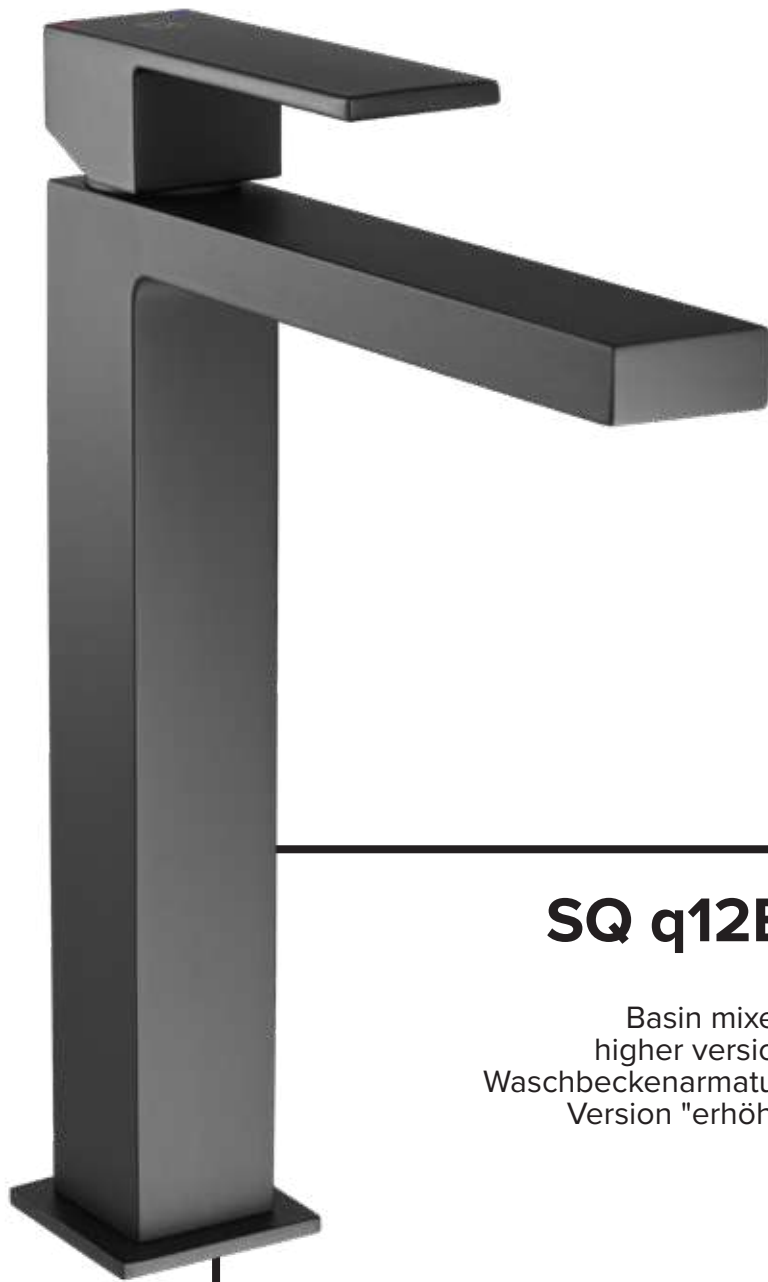

## SQ q12B

Basin mixer;  
higher version  
Waschbeckenarmatur;  
Version "erhöht"



00058B



## SQ q11B

Basin mixer  
Waschbeckenarmatur



00057B

27

## SQ q50B

Bidet mixer  
Bidetarmatur



00595B



# SQ q30B

Bath/shower mixer  
Wannen-/Duscharmatur



00360B

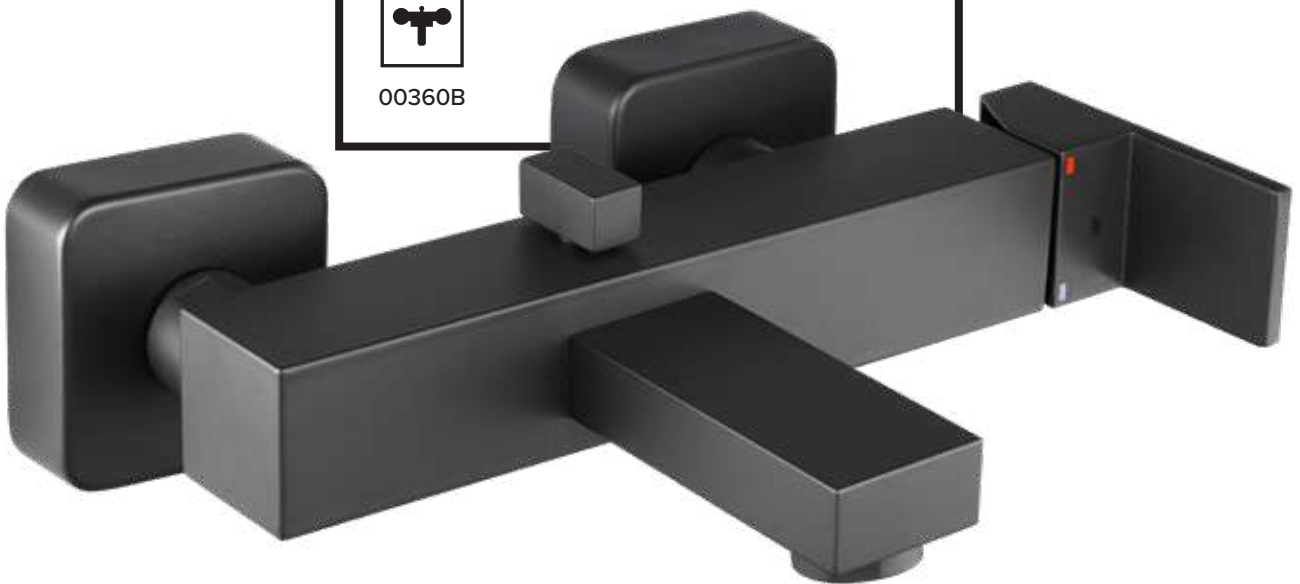



## SQ q40B

Shower mixer  
Duscharmatur



00494B



# SQ q12

Basin mixer;  
higher version  
Waschbeckenarmatur;  
Version "erhöht"



00058



## SQ q11

Basin mixer  
Waschbeckenarmatur



00057

## SQ q50

Bidet mixer  
Bidetarmatur



00595



# SQ q30

Bath/shower mixer  
Wannen-/Duscharmatur



00360







## SQ q40

Shower mixer  
Duscharmatur



00494

# DESIGN SERIES



/ Soft curves and rounded shapes of Zen line are the right choice for those who love tradition, but at the same time appreciate modern design. The tapware also features a handle that is extremely pleasant to touch and allows precise water regulation. The Zen line is a perfect harmony of elegance and usability.



Z

E

N

/ Weiche Kurven und abgerundete Formen der Zen-Linie sind die richtige Wahl für diejenigen, die Tradition lieben und gleichzeitig modernes Design schätzen. Tapware verfügt auch über einen Griff, der sich sehr angenehm anfühlt. Die Zen-Linie ist ein perfekter Kompromiss zwischen Eleganz und Benutzerfreundlichkeit.

## Zen u11B

Basin mixer  
Waschbeckenarmatur



00077B



## Zen u50B

Bidet mixer  
Bidetarmatur



00530B





## Zen u30B

Bath/shower mixer  
Wannen-/  
Duscharmatur



00330B

37

## Zen u40B

Shower mixer  
Duscharmatur



00430B



## Zen u11

Basin mixer  
Waschbeckenarmatur



00077



## Zen u50

Bidet mixer  
Bidetarmatur



00530





## Zen u30

Bath/shower mixer  
Wannen-/  
Duscharmatur



00330

## Zen u40

Shower mixer  
Duscharmatur



00430



**NEW**

# DESIGN SERIES



/ The Lino range is a combination of straight and curved shapes that complement each other to create an elegantly simple look. The straight lines are the perfect solution for contemporary interiors, while the softer, rounded shapes are a great match for traditionally designed interiors. The mixer has a slightly raised handle design, making it even easier to operate.





/ Die Serie Lino ist eine Kombination aus geraden und abgerundeten Formen, die sich gegenseitig ergänzen und ein elegantes, schlichtes Aussehen schaffen. Die geraden Linien sind die perfekte Lösung für moderne Innenräume, während die weicheren, abgerundeten Formen gut zu traditionell gestalteten Räumen passen. Die Armatur ist mit einem leicht erhöhten Griff ausgestattet, der die Bedienung noch einfacher macht. Die Serie Lino wird Ihr Bad ästhetisch vervollständigen, denn sie umfasst eine Duscharmatur, eine Waschtischarmatur sowie eine Unterputzversion.



# Lino I12

Basin mixer;  
higher version  
Waschbeckenarmatur;  
Version "erhöht"

**NEW**



00096



## Lino I11

Basin mixer  
Waschbeckenarmatur

**NEW**



00095



00078

## Lino I50

Bidet mixer  
Bidetarmatur

**NEW**



00590



# Lino I30

Bath/shower mixer  
Wannen-/Duscharmatur

**NEW**



00396





## Lino I40

Shower mixer  
Duscharmatur

**NEW**



00490

# DESIGN SERIES



/ Elegant combining of straight and curved lines supplemented with care for the environment by water saving ECO aerators, pampers you in your daily use. The mixer is fitted with an aerator of the highest quality that enables the water flow of 6 l per minute. INIFINITY basin mixer therefore represents an elegant and useful blend of modern design and care for the environment at the same time.



# K E I N E N

/ Die elegante Kombination von geraden und runden Linien im Einklang mit nachhaltigem Umweltschutz durch den Einsatz von wassersparenden ECO-Perlatores verwöhnt sie tagtäglich. Die Armatur ist mit einem Perlator höchster Qualität ausgestattet, welcher einen Wasserdurchfluss von 6 l/min ermöglicht. Die INFINITY Waschtischarmatur steht für eine gleichermaßen elegante und nützliche Vereinigung von modernem Design und Achtung der Umwelt.



## Infinity i11

Basin mixer;  
higher version  
Waschbeckenarmatur;  
Version "erhöht"



00014

00012



00013



00011



01012



01011



00053

## Infinity i10

Basin mixer\*  
Waschbeckenarmatur\*



00004



00002



00003



00001



\* Also available: base for basin/bidet mixer, product no. 19219.

\* Auch erhältlich: Sockel für Waschtischbatterie, Artikelnummer 19219.



/ All basin mixers include eco aerator that enables the water flow of 6 l/min.  
/ Wannen-/Duscharmaturen und Duscharmaturen mit Duschgarnitur enthalten Wassermengenregler, die einen Wasserdurchfluss von 6 l/min ermöglichen.





## Infinity i50

Bidet mixer  
Bidetarmatur



00503



00501



\* Also available: base for basin/bidet mixer, product no. 19219.

\* Auch erhältlich: Sockel für Waschtischbatterie, Artikelnummer 19219.



## Infinity i01

Fittings with  
medical handle  
Armatur mit  
medizinischem Griff



00006

Note: length of handle 200 mm  
Anmerkung: länge des Griffs 200 mm



## Infinity i30

Bath/shower mixer  
Wannen-/Duscharmatur



00301



00302



00303



00311



/ Bath/shower mixers and shower mixers with shower set include water flow regulator that enables the water flow of 9 l/minute.

/ Wannen-/Duscharmaturen und Duscharmaturen mit Duschgarnitur enthalten Wassermengenregler, die einen Wasserdurchfluss von 9 l/min ermöglichen.



## Infinity i40

Shower mixer  
Duscharmatur



00401



00402



00403



00411

SETS  
SETS

# Infinity i101

SET

00059



00012



00301



12460

SETS  
SETS

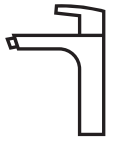

**Infinity  
i101**

SET

00060



00012



00401



12460

SETS  
SETS

**Infinity  
i102**

SET

00069



00002



00301



12460

SETS  
SETS

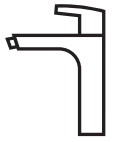

**Infinity  
i103**

SET

00070



00002



00401



12460

# DESIGN SERIES



/ The Fresh line tapware can fit into every modern bathroom due to their modern, trendy round lines, elaborate details and various versions of washbasin tapware. These are elaborate products in terms of their design and function, providing satisfaction to their users with their design and daily use.





# FRESH LINE

/ Die Waschtischarmaturen der Fresh-Line integrieren sich Dank ihrer trendig gerundeten Linien und aufwändigen Details in jedes moderne Badezimmer. Durchdacht in Design und Funktion setzen Fresh-Armaturen immer formschöne Akzente.



## Fresh f12

Basin mixer;  
higher version  
Waschbeckenarmatur;  
Version "erhöht"



150  
mm



150  
mm



200  
mm



200  
mm



150  
mm



00048



00049



00600



00601



00042



## Fresh f11

Basin mixer  
Waschbeckenarmatur



00039



00038



00040



00035



01035



01036



## Fresh f50

Bidet mixer  
Bidetarmatur



00537



00536



00535



00538



**Fresh f15**

Basin mixer  
Waschbeckenarmatur





00045    00044



**Fresh f85**

Flush-mounted basin mixer  
Unterputz-Waschtischarmatur

**NEW**

00034

Note: 12708 – extension option  
Anmerkung: 12708 - Verlängerungsoption



## Fresh f30

Bath/shower mixer  
Wannen-/Duscharmatur



00334



00337



00335



## Fresh f40

Shower mixer  
Duscharmatur



00434



00438



00435

# FRESH

## THERMOSTATIC MIXERS

## THERMOSTAT ARMATUREN



/ Elegant round lines complete the exceptional usability of the thermostatic tapware of the Fresh line beautifully. The option of setting the desired temperature provides a special comfort and practicality, ensuring savings in consumed hot water and protection against burning, which is of particular importance for families with small children. The surface of the tapware does not get hot during its use and is, thus, perfectly safe to touch.

/ Elegante Rundungen sorgen für ein ansprechendes Design bei den Thermostatarmaturen aus der Fresh-Kollektion. Die Einstellung der Wunschtemperatur ist komfortabel und praktisch zugleich. Sie ermöglicht es, warmes Wasser zu sparen und schützt vor Verbrennungen, was für Familien mit Kindern sehr wichtig ist. Die Armaturenoberfläche erhitzt sich nicht und ist somit auch absolut berührungssicher.

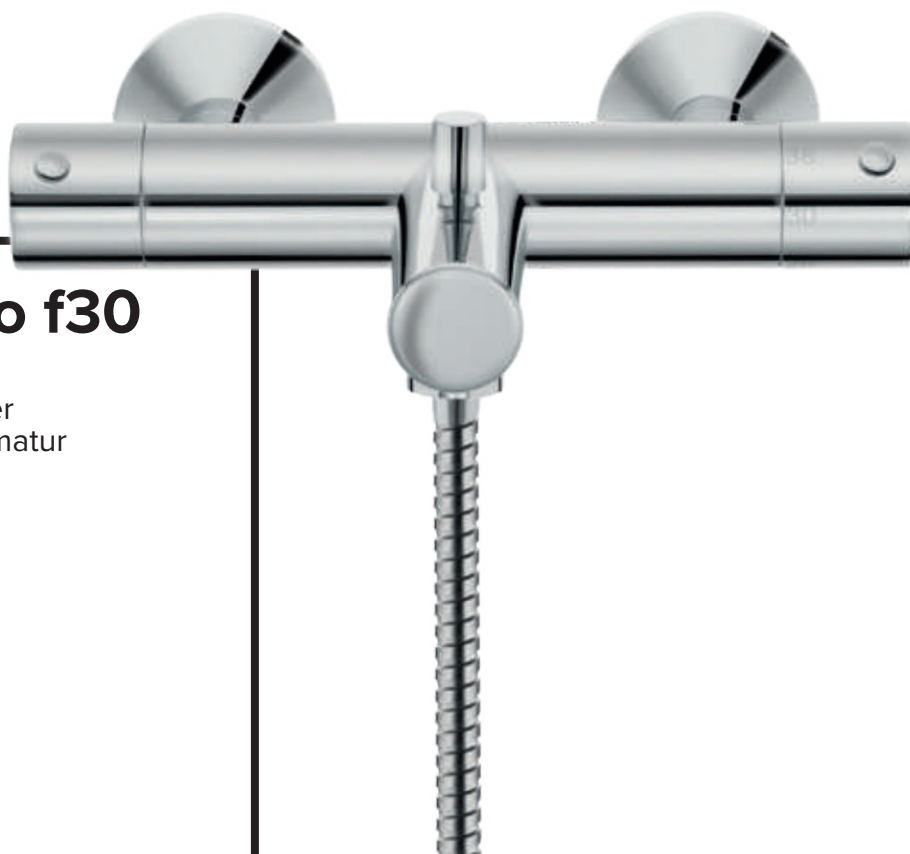

## Fresh termo f30

Thermostatic bath mixer  
Thermostat-Wannenarmatur



00339



00336

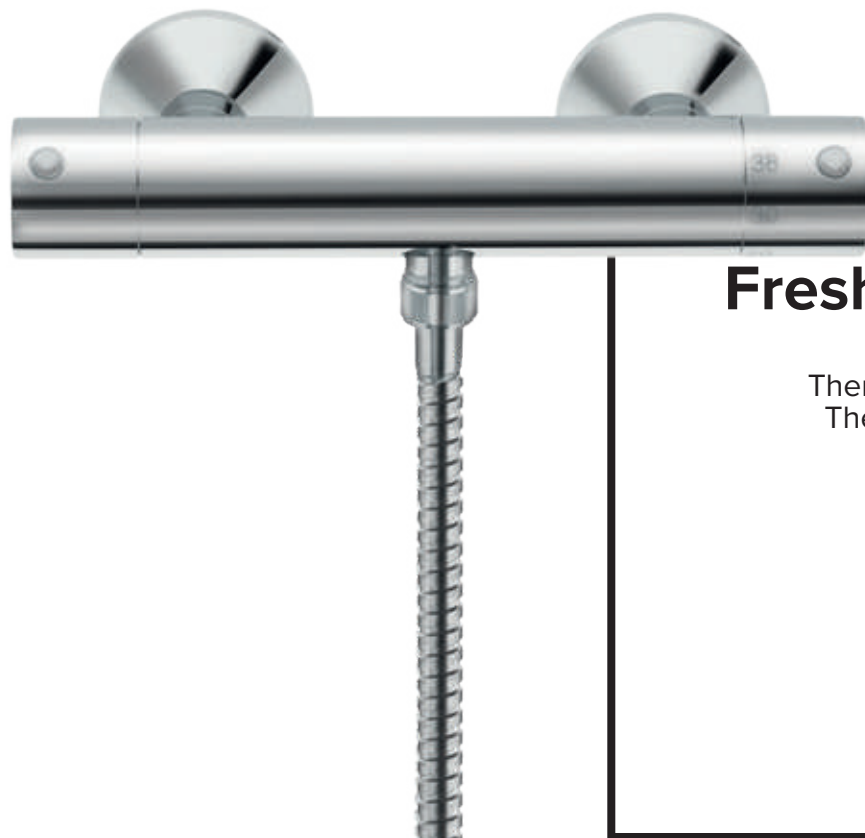

## Fresh termo f40

Thermostatic Shower mixer  
Thermostat-Duscharmatur



00440



00437

# FRESH IR

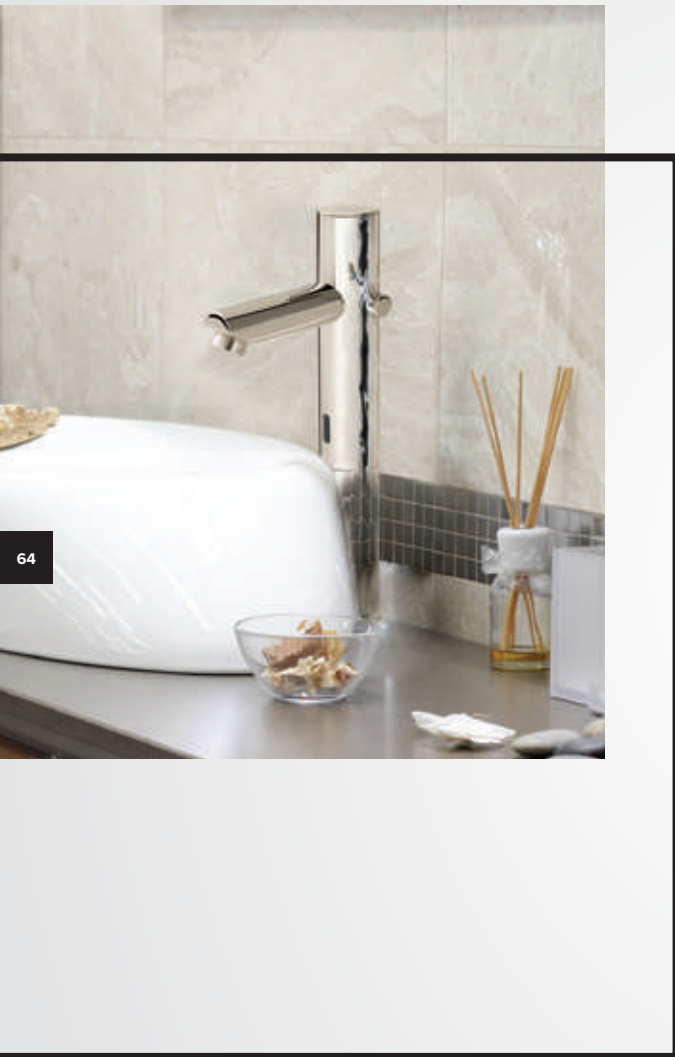

## SENSOR MIXERS SENSOR- ARMATUREN

A well thought-out and elaborate design combined with top-notch functionality

/ In addition to advantages as to hygiene, the sensor tapware provides comfort and safety to its users in setting the temperature beforehand, as well as water consumption savings. Therefore, more and more people decide also to use sensor tapware at home. The Fresh line comprises mixing and non-mixing washbasin tapware of different forms in battery and network versions.

Durchdachtes und ansprechendes Design kombiniert mit Top-Funktionalität

/ Neben hygienischen Vorteilen bieten die FRESH-Line-Sensorarmaturen auch Komfort und Sicherheit bei der Temperatureinstellung und reduzieren den Wasserverbrauch. Daher entscheiden sich immer mehr Menschen für die Verwendung von senorgesteuerten Armaturen auch im privaten Bereich. Die FRESH-Kollektion bietet eine große Auswahl an formschönen Armaturen mit und ohne Mischbatterie - ein innovativer Akzent auch für Ihr zuhause.





## Fresh IR f11

Sensor basin mixer  
Sensor-Waschbeckenarmatur



09124



09116



09117



Note: 09124 is combined with 19806 (adapter) and 19807 (adapter connector). 6 fittings can be connected to 1 adapter (p. 60).

Anmerkung: 09124 wird mit 19806 (Adapter) und 19807 (Adapter-Anschluss) kombiniert. 6 Fittings können an 1 Adapter angeschlossen werden (S. 60).



## Fresh IR f12

Sensor basin mixer  
–high version  
Sensor-Waschbeckenarmatur  
– erhöhte Version



09125



09120



09121

Note: 09125 is combined with 19806 (adapter) and 19807 (adapter connector). 6 fittings can be connected to 1 adapter (p. 60).

Anmerkung: 09125 wird mit 19806 (Adapter) und 19807 (Adapter-Anschluss) kombiniert. 6 Fittings können an 1 Adapter angeschlossen werden (S. 60).

/ FRESH-IR for cold or premixed water, 9V battery or 230V mains power, programmable electronics.

/ FRESH-IR für kaltes oder vorgemischtes Wasser, 9V-Batterie oder 230V-Netzstrom, programmierbare Elektronik.

## Fresh IR mix f11

Sensor basin mixer  
Sensor-Waschbeckenarmatur



09126



09118



09119

Note: 09126 is combined with 19806 (adapter) and 19807 (adapter connector). 6 fittings can be connected to 1 adapter (p. 60).  
Anmerkung: 09126 wird mit 19806 (Adapter) und 19807 (Adapter-Anschluss) kombiniert. 6 Fittings können an 1 Adapter angeschlossen werden (S. 60).

## Fresh IR mix f12

Sensor basin mixer  
– high version  
Sensor-Waschbeckenarmatur  
– erhöhte Version



09127



09122



09123

Note: 09127 is combined with 19806 (adapter) and 19807 (adapter connector). 6 fittings can be connected to 1 adapter (p. 60).  
Anmerkung: 09127 wird mit 19806 (Adapter) und 19807 (Adapter-Anschluss) kombiniert. 6 Fittings können an 1 Adapter angeschlossen werden (S. 60).





## Fresh IR f65

Urinal sensor flusher/battery version  
Urinal Sensorspüler / Batterieversion



09510



## Fresh IR f60

Concealed urinal sensor flusher  
-Installation set  
Unterputz - Urinal Sensorspüler  
Einbauset



09511



09512

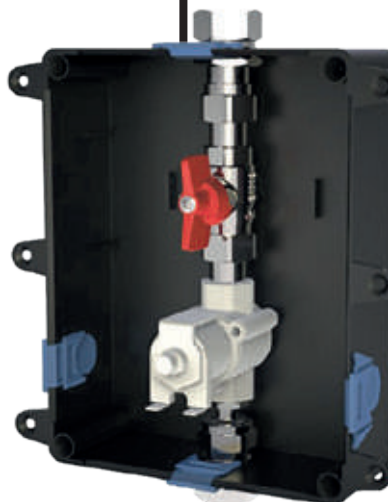

09511 Concealed, 1/2",  
9 V without cover plate  
Unterputz, 1/2",  
9 V ohne Abdeckplatte

09512 Concealed, 1/2",  
230 V without cover plate  
Unterputz, 1/2",  
230 V ohne Abdeckplatte



## Fresh IR f61

Covering plate with sensor  
Abdeckplatte mit Sensor

/ Cover plate with sensor,  
for products 09511 in 09512.  
ABS, white  
/ Abdeckplatte mit Sensor  
für Produkt 09511 und 09512.  
ABS, weiß

12261



## Fresh IR f62

Covering plate with sensor  
Abdeckplatte mit Sensor

/ Cover plate with sensor,  
for products 09511 in 09512.  
ABS, chrome mat  
/ Abdeckplatte mit Sensor  
für Produkt 09511 und 09512.  
ABS, chrom-matt

12263



## Elite IR e60

Flush-mounted electronic urinal flusher,  
wall-mounted set, cover plate with  
sensor  
Elektronische Toilettenspülung für  
die Unterputzmontage, Set für die  
Wandmontage, Abdeckplatte mit Sensor

**NEW**



09521



09522

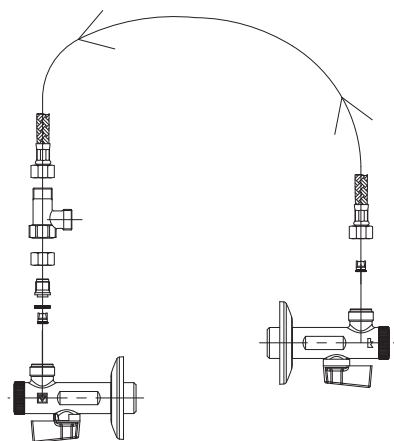

# 12704

Premixing set  
Vormischungsset

**NEW**

Note: for products: 09116, 09117, 09120, 09121, 09124, 09125  
Anmerkung: für Produkte: 09116, 09117, 09120, 09121, 09124, 09125

# 19806

230/9V adapter for  
connecting to  
6 fittings in total  
Adapter 230/9V zum  
Anschluss von insgesamt  
bis zu 6 Armaturen

**NEW**



INPUT:  
110-240VAC  
AC/N  
AC/L

OUTPUT:  
9VDC  
222mA  
-Vo<sup>+</sup>  
+Vo<sup>-</sup>



Note: the adapter is 36 x 32 x 21 mm  
Anmerkung: der Adapter ist 36 x 32 x 21 mm

# 19807

Adapter connector 19806  
Adapter-Anschluss 19806

**NEW**



Note: the length of the connector is 250 mm  
Anmerkung: die Länge des Steckers beträgt 250 mm



# CLASSIC SERIES

BATHROOM  
BADEZIMMER



# Harmony h10

Basin mixer  
Waschbeckenarmatur



00093



00092



00094



00091



01096



01095



# Harmony h50

Bidet mixer  
Bidetarmatur



00594



00592



00591





## Harmony h30

Bath/shower mixer  
Wannen-/Duscharmatur



00395



00393



00394



## Harmony h40

Shower mixer  
Duscharmatur



00493



00491



00492

## Project m10

Basin mixer\*  
Waschbeckenarmatur\*



00026



00024



00025



00023



\* Also available: base for basin/bidet mixer, product no. 19228.

\* Auch erhältlich: Sockel für Waschtischbatterie, Artikelnummer 19228.

## Project m50

Bidet mixer\*  
Bidetarmatur\*



00518



00516



00515



\* Also available: base for basin/bidet mixer, product no. 19228.

\* Auch erhältlich: Sockel für Waschtischbatterie, Artikelnummer 19228.



## Project m30

Bath/shower mixer  
Wannen-/Duscharmatur



00326



00325



75

## Project m40

Shower mixer  
Duscharmatur



00427



00425



## Simpaty s10

Basin mixer  
Waschbeckenarmatur



00084



00082



00083



00081



01081



01082



## Simpaty s50

Bidet mixer  
Bidetarmatur



00584



00582



00581



## Simpaty s01

Washbasin mixer – medical  
Waschtischmischer – medizinisch



00037



/ All sanitary mixers of the Simpaty family  
can be equipped with a medical lever.  
/ Alle Sanitärarmaturen der Simpaty-Familie  
können mit einem medizinischen Hebel  
ausgestattet werden.

77

## Simpaty s32

Mixer for sink and bath  
Mischer für Waschbecken und  
Badewanne



00387



00383



00386



## Simpaty s31

Bath/shower mixer  
Wannen-/Duscharmatur



00388



00389



## Simpaty s30

Bath/shower mixer  
Wannen-/Duscharmatur



00380



00381



00384



## Simpaty s40

Bath/shower mixer  
Wannen-/Duscharmatur



00480



00481



00482

### STIL sanitary mixers

An interesting interlacement of classical forms and vintage, retro lines is associated with beautiful details in chrome or gold. Giving your home a touch of tradition and homeliness

### STIL Sanitärarmaturen

Die klassische Form mit Retro-Elementen wird hervorgehoben durch wunderschöne verchromte und vergoldete Details.

## Stil z11\*

Basin mixer  
Waschbeckenarmatur



07066



07072



07061



## Stil z12\*

Basin mixer  
Waschbeckenarmatur



07067



07077



07062



\* version chrome - gold

\* Ausführung Chrom - Gold





## Stil z30\*

Bath/shower mixer  
Wannen-/Duscharmatur



07357

## Stil z40\*

Shower mixer  
Duscharmatur



07465



07462



81

## Stil z50\*

Bidet mixer  
Bidetarmatur



07558



07554

\* version chrome - gold

\* Ausführung Chrom - Gold

## Stil z11

Basin mixer  
Waschbeckenarmatur



07068



07073



07063



## Stil z12

Basin mixer  
Waschbeckenarmatur



07078



07079



07064





## Stil z30

Bath/shower mixer  
Wannen-/Duscharmatur



07358

## Stil z40

Shower mixer  
Duscharmatur



07466



07464



## Stil z50

Bidet mixer  
Bidetarmatur



07559



07555



## Val v11

Basin mixer  
Waschbeckenarmatur



07074



07060



07053



07055

## Val v12

Washbasin mixer "J"-outflow  
Waschtischmischer "J"-Auslauf



07065



07076



07057



07059



## Val v50

Bidet mixer  
Bidetarmatur



07550



07557



07553





## Val v40

Shower mixer  
Duscharmatur



07454



07452

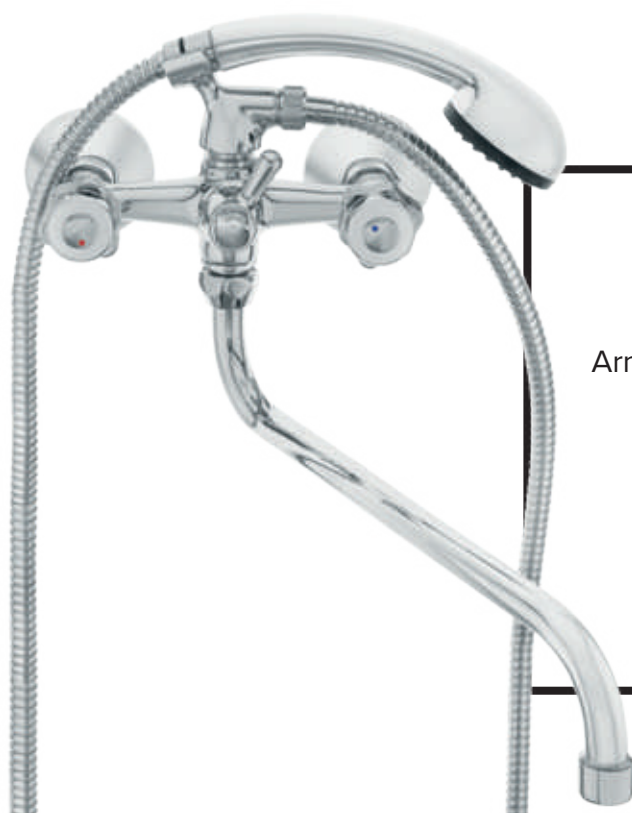

## Val v31

Mixer for sink and bath  
Armatur für Waschbecken und  
Badewanne



07356

## Val v30

Bath/shower mixer  
Wannen-/Duscharmatur



07355



## Classic c01

Basin mixer  
Waschbeckenarmatur



10052



Note:

Available in combination with Stil handle (with ceramic upper part).

Anmerkung:

Auch in Kombination mit Stil Griff erhältlich (Keramik-Oberteil).



10072

## Classic c02

Basin mixer  
Waschbeckenarmatur

Note:  
Available in combination with Stil handle (with ceramic upper part).

Anmerkung:  
Auch in Kombination mit Stil Griff erhältlich (Keramik-Oberteil).



10171



10151

## Classic c06

Basin mixer  
Waschbeckenarmatur



10352



Note:

Available in combination with Stil handle (with ceramic upper part).

Anmerkung:

Auch in Kombination mit Stil Griff erhältlich (Keramik-Oberteil).



10372



Note:  
Available in combination with Stil  
handle (with ceramic upper part).  
Anmerkung:  
Auch in Kombination mit Stil Griff  
erhältlich (Keramik-Oberteil).



10374



## Classic c07

Basin mixer  
Waschbeckenarmatur



10354

## Classic c13

Basin mixer  
Waschbeckenarmatur



10652



Note:  
Available in combination with Stil  
handle (with ceramic upper part).  
Anmerkung:  
Auch in Kombination mit Stil Griff  
erhältlich (Keramik-Oberteil).



10672

Note:  
Available in combination with Stil  
handle (with ceramic upper part).  
Anmerkung:  
Auch in Kombination mit Stil Griff  
erhältlich (Keramik-Oberteil).



10571



## Classic c15

Basin mixer  
Waschbeckenarmatur



10551



## Classic c04

Basin mixer  
Waschbeckenarmatur



10251



## Classic c05

Basin mixer  
Waschbeckenarmatur



10351



## Classic c14

Basin mixer  
Waschbeckenarmatur



10651



## Classic c08

Basin mixer  
Waschbeckenarmatur



10355



## Classic c03

Water tap - valve  
Wasserhahn - Ventil



10152



## Classic c09

Water tap - valve  
Wasserhahn - Ventil



10356



Note: for washing machine or dishwasher 3/4"  
Anmerkung: für Waschmaschine oder Geschirrspüler 3/4"

## Classic c43

Water tap - hand shower  
Wasserhahn - Handbrause



10451







## Classic c11

Basin mixer  
Waschbeckenarmatur



05056 05055



## Classic c50

Bidet mixer  
Bidetarmatur



05554 05557 05553



## Classic c30

Bath/shower mixer  
Wannen-/Duscharmatur



05351



## Classic c31

Mixer for sink and bath  
Armatur für Waschbecken  
und Badewanne



05355



### Classic c40

Shower mixer  
Duscharmatur



05452 05451



### Classic c44

Water tap - shower fixed  
Wasserhahn - Stehbrause



10452



### Classic c42

Bath/shower mixer  
Wannen-/Duscharmatur



05455



### Classic c41

Shower mixer  
Duscharmatur



05454

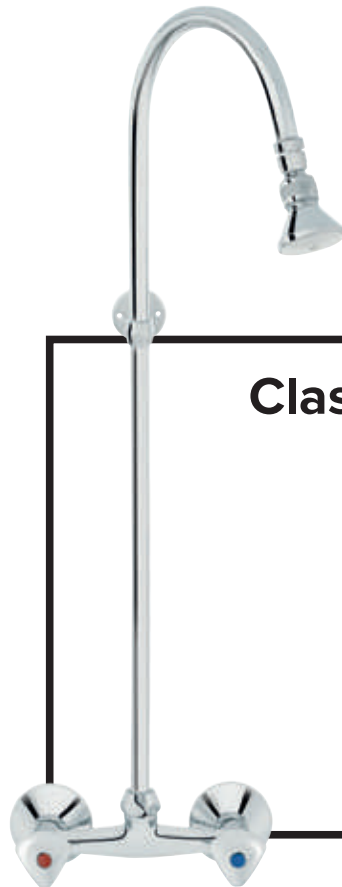

## Push mix p10

Mixing Self-closing tap for basin  
Selbstschließende  
Waschtischarmatur



00030



# PUSH



PUSH  
MIXERS

PUSH  
ARMATUREN

## Push p10

Self-closing tap for basin  
Selbstschließende  
Waschtischarmatur



00029



## Push p65

Self-closing tap for urinal  
Selbstschließende -Urinal  
Armatur



00031



## Push p15

Self-closing tap for basin  
Selbstschließende  
Waschtischarmatur



00033



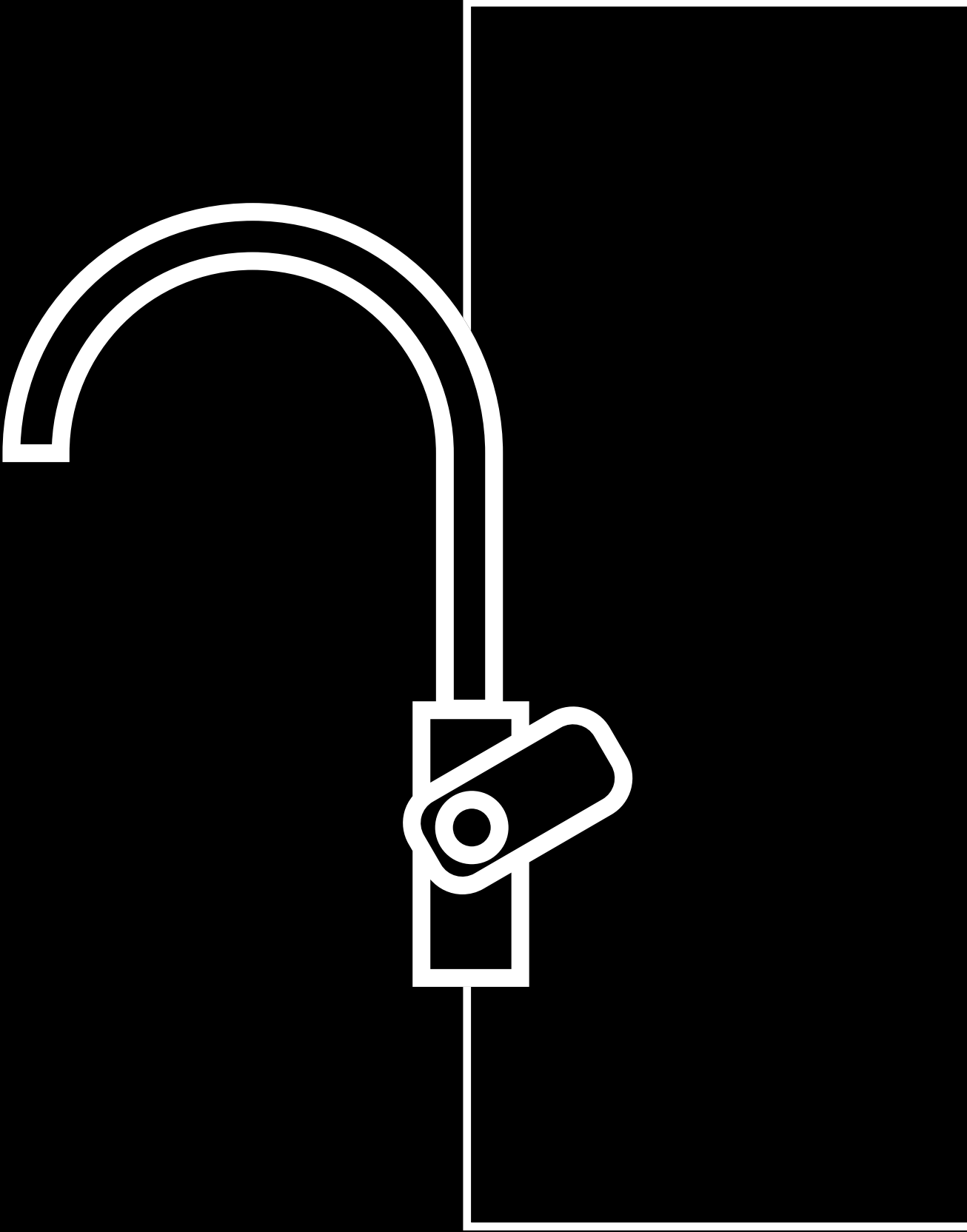

KITCHEN  
KÜCHE



# DESIGN SERIES

KITCHEN  
KÜCHE

# DESIGN SERIES



/ The Elite line fits into the interior with modern equipment excellently, and the tap-ware, as the central element of your kitchen, will thus attract many approving glances. The synergy of straight and rounded lines emphasises the elegance of clearly defined straight shapes or softer curves of kitchen units and completes the visual image of your kitchen in a selected manner. A simple and economical selection for a top-notch effect.





/ Die Elite-Kollektion ist durch die Verbindung von zeitgenössischem Design mit Funktionalität ein absoluter Blickfang auch in Ihrer Küche. Mit eleganter Schlichtheit unterstreichen Elite-Armaturen die klar definierten Formen modernen Kücheninterieurs. Und das zu einem sehr attraktiven Preis-/Leistungsverhältnis.



## Elite e20B

Sanitary kitchen mixer  
Küchenarmatur



00101B



01101B

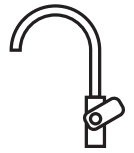

## Elite e20Ni\*

Sanitary kitchen mixer\*  
Küchenarmatur\*



00103Ni



01107Ni

\* brushed nickel

\* nickel gebürstet



## Elite e20

Sanitary kitchen mixer  
Küchenarmatur



00101



00102



01101



## Elite side e20

Sanitary kitchen mixer  
Küchenarmatur



00103



01107



## Elite e21

Sanitary kitchen mixer  
Küchenarmatur



00104



00105



01102

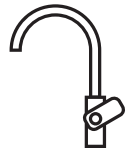

## Elite side e21

Sanitary kitchen mixer  
Küchenarmatur



00106



01108



## Elite e22

Sanitary kitchen mixer  
with pullout spray  
Küchenarmatur  
mit Auszugsbrause



00111



00112



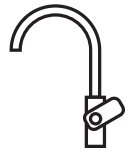

## Elite side e22

Sanitary kitchen mixer  
with pullout spray  
Küchenarmatur  
mit Auszugsbrause



00113



## Elite e23

Sanitary kitchen mixer  
with pullout spray  
Küchenarmatur  
mit Auszugsbrause



00114



00115

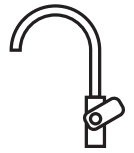

## Elite side e23

Sanitary kitchen mixer  
with pullout spray  
Küchenarmatur  
mit Auszugsbrause



00116





## Elite e24

Sanitary kitchen mixer  
with flexible spout  
Küchenarmatur  
mit flexiblem Auslauf



00120



01120

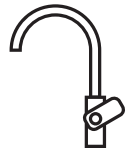

## Elite side e24

Sanitary kitchen mixer  
with flexible spout  
Küchenarmatur  
mit flexiblem Auslauf



00121



01121

# DESIGN SERIES



/ Infinity kitchen mixers with their modern lines and simplicity of use can be easily placed into any contemporary kitchen. The combination of straight and curved lines appears elegant, but yet contemporary. Sophisticated design united with deliberate solutions and range of possibilities in different spouts offering the optimal choice for reliability and the freedom of use in your kitchen. Our assortment of INFINITY kitchen mixers includes the models with three types of fully movable spouts and side handles that can be used on the left or right side.



# K E I N E N Z E I N

/ Infinity Küchenarmaturen passen mit ihren modernen, eleganten Linienführung in jede moderne Küche. Durchdachte Lösungen, funktionale Bedienelemente und mehrere Modellvarianten sind perfekt auf die Anforderungen im Küchenbereich abgestimmt. Links- und rechtshändige Montage für individuellen Bedienkomfort möglich.



# Infinity i20

Sanitary kitchen mixer  
Küchenarmatur



00170



00169



01169



# Infinity i21

Sanitary kitchen mixer  
Küchenarmatur



00172



00171



01171



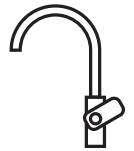

## Infinity i70

Sanitary wall mixer  
Wandarmatur

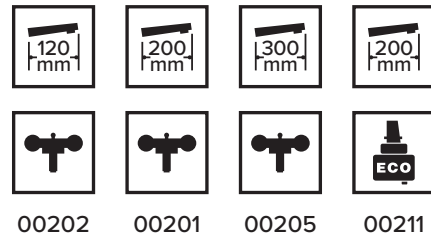

## Infinity i71

Sanitary kitchen mixer  
- medical  
Küchenarmatur  
- medizinisch



00208



Note: length of handle 200 mm  
Anmerkung: länge des Griffs 200 mm





## Infinity i22

Sanitary kitchen mixer  
Küchenarmatur



00174



00173



01173



## Infinity i23

Sanitary kitchen mixer  
Küchenarmatur



00176



00175



01175

# DESIGN SERIES



/ Elaborate design and the play of softer shapes in the Fresh line for kitchens is combined with a range of practical solutions. The tapware, with a flexible outlet in case your kitchen sink is placed by the window, is certainly something special. Thus, the window can be opened and shut freely. The thermostatic kitchen tapware enabling hot water savings and protection against burning also stands out in the Fresh line.



I

S

E

R

L

/ Aufwändiges Design und das Spiel weicher Formen: die Fresh-Line kombiniert moderne Optik mit innovativer Funktionalität. Sie möchten von Ihrer Spüle aus direkt aus dem Fenster blicken? Kein Problem mit den kippbaren Unterfenster-Armaturen, wodurch Ihr Küchenfenster problemlos geöffnet bzw. geschlossen werden kann. Innovativ ist auch die Armatur mit Thermostاتفunktion zur Reduktion des Warmwasserverbrauchs und mit Verbrühschutz. Geniale Ideen auf den Punkt gebracht.

# Fresh f22

Sanitary kitchen mixer  
– flexible spout  
Küchenarmatur  
– flexibler Auslauf



00136



00135



01138

Flexibility: forwards 100°, backwards 10°  
Flexibilität: vorwärts 100°, rückwärts 10°



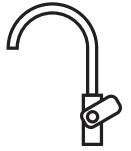

## Fresh f23

Sanitary kitchen mixer  
– flexible spout  
Küchenarmatur  
– flexibler Auslauf



00147



00145



01146

Flexibility: forwards 100°, backwards 10°  
Flexibilität: vorwärts 100°, rückwärts 10°



## Fresh f24

Sanitary kitchen mixer  
– flexible spout  
Küchenarmatur  
– flexibler Auslauf



00146



00144



01145



Flexibility: forwards 100°, backwards 10°  
Flexibilität: vorwärts 100°, rückwärts 10°





# Fresh f21

Sanitary kitchen mixer  
Küchenarmatur



00133



00134



01137



01140



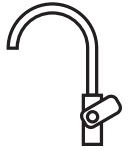

## Fresh f25

Sanitary kitchen mixer  
Küchenarmatur



00131



00132



01143



01144



121



## Fresh f26

Sanitary kitchen mixer  
Küchenarmatur



00129



00130



01141



01142

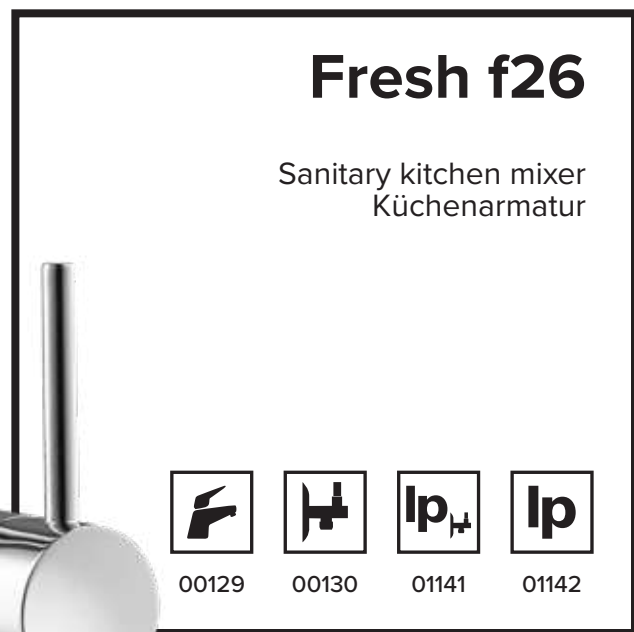



## Fresh f20

Sanitary kitchen mixer  
with pullout spray  
Küchenarmatur  
mit Auszugsbrause



00138



00137

/ Uniquely designed shape of mixer that enables to direct the water jet randomly in the harder reachable parts of dishes. Ideal for deeper kitchen sinks. Easy opening.  
/ Die einzigartige Ausführung der Armatur variiert den Wasserstrahl nach dem Zufallsprinzip, sodass auch schwer zugängliche Bereiche des Geschirrs sauber gespült werden. Ideal für tiefere Küchenspülen geeignet. Einfaches Öffnen.





# CLASSIC SERIES

KITCHEN  
KÜCHE



# Project m20

Sanitary wall kitchen mixer  
Wandarmatur für die Küche



00185



00184



01185

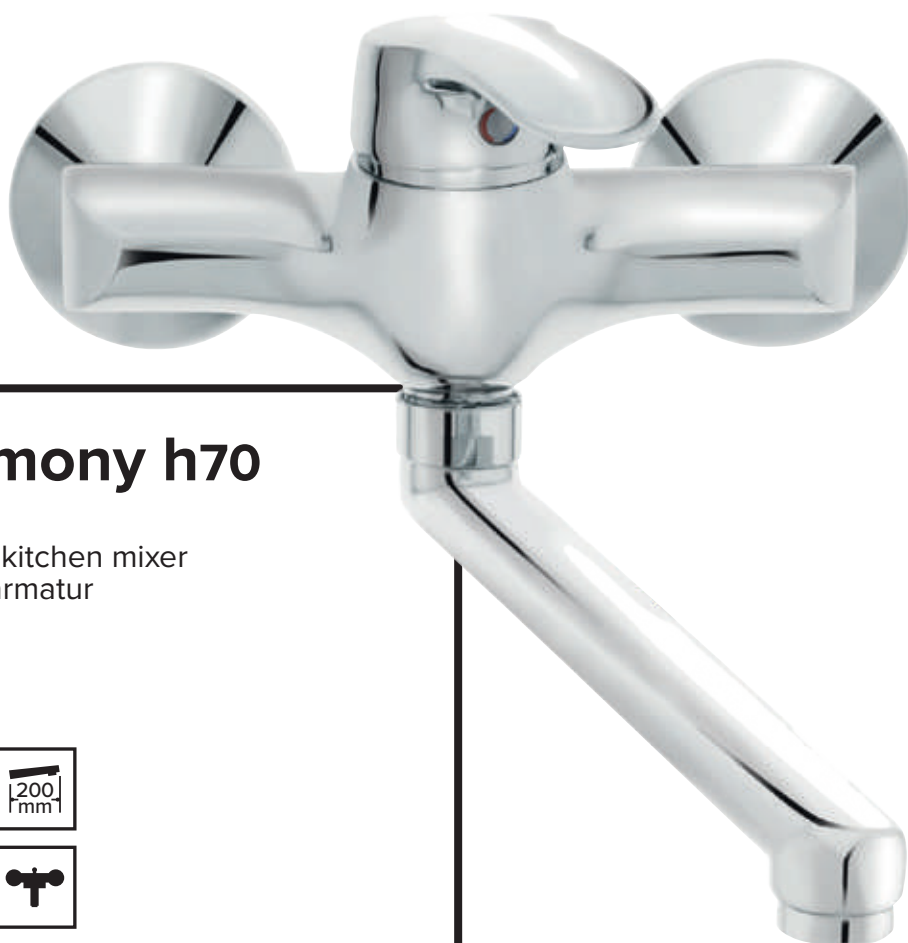

## Harmony h70

Sanitary kitchen mixer  
Küchenarmatur



00292

00291



# Simpaty s20

Sanitary kitchen mixer  
Küchenarmatur



00186



00182



01182



01184



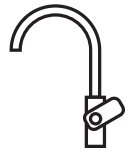

## Simpaty s21

Sanitary kitchen mixer  
Küchenarmatur



00183



00181



01183



01181



00180

## Simpaty s70

Sanitary wall kitchen mixer  
Wandarmatur für die Küche



00282



00281



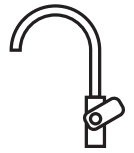

## Simpaty s75

Sanitary wall kitchen mixer  
Wandarmatur für die Küche



01281



## Simpaty s71

Basin mixer  
– for hospitals  
Waschbeckenarmatur  
– für Krankenhäuser



00237



Note: length of handle 200 mm  
Anmerkung: länge des Griffs 200 mm



## Stil z70\*

Sanitary kitchen mixer  
Küchenarmatur



07260

## Stil z71\*

Sanitary kitchen mixer  
Küchenarmatur



07261



## Stil z72\*

Sanitary kitchen mixer  
Küchenarmatur



07262



\* version chrome - gold  
\* Ausführung Chrom - Gold

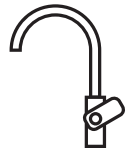

## Stil z20\*

Sanitary kitchen mixer  
Küchenarmatur



07162



07156



08149

## Stil z21\*

Sanitary kitchen mixer  
Küchenarmatur



07165



07157



08163

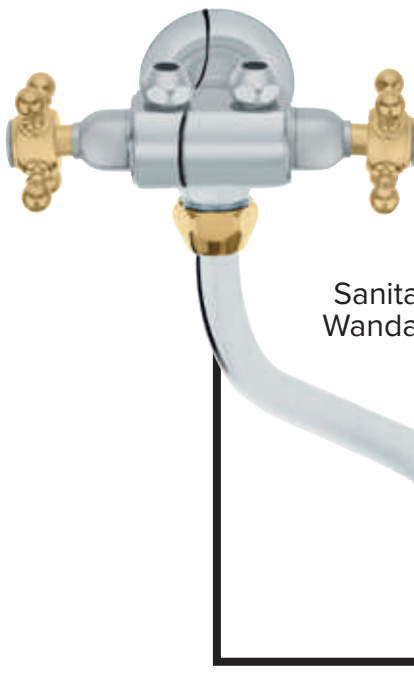

## Stil z75\*

Sanitary wall kitchen mixer  
Wandarmatur für die Küche



08255

\* version chrome - gold  
\* Ausführung Chrom - Gold

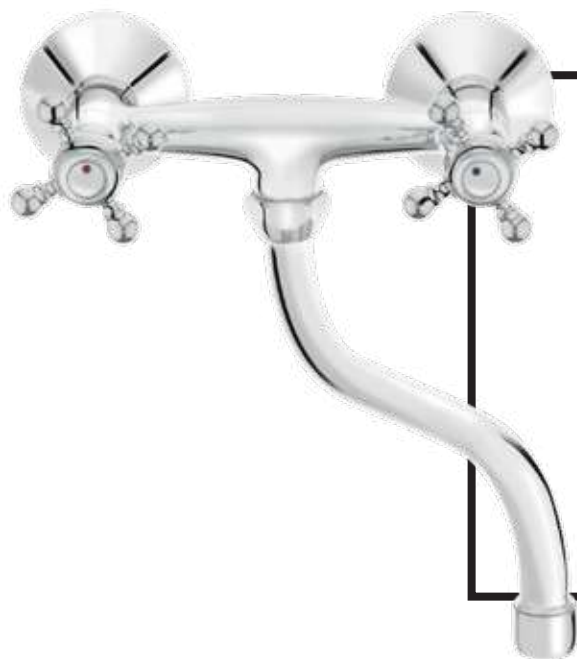

## Stil z70

Sanitary kitchen mixer  
Küchenarmatur



07263

## Stil z71

Sanitary kitchen mixer  
Küchenarmatur



07264



## Stil z72

Sanitary kitchen mixer  
Küchenarmatur



07265





## Stil z20

Sanitary kitchen mixer  
Küchenarmatur



07169



07158



08150

## Stil z21

Sanitary kitchen mixer  
Küchenarmatur



07163



07159



08161



01164



## Stil z75

Sanitary wall kitchen mixer  
Wandarmatur für die Küche



08256

## Val v20

Kitchen mixers "HU"-outflow  
Küchenarmatur "HU"-Auslauf



07164



07153



08148



08153

## Val v21

Kitchen mixers "J"-outflow  
Küchenarmatur "J"-Auslauf



07161



07155



08166



08155

## Val v75

Sanitary wall kitchen mixer  
Wandarmatur für die Küche



08253



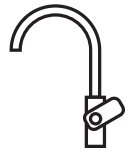

## Val v70

Sanitary kitchen mixer  
Küchenarmatur



07257

## Val v71

Sanitary kitchen mixer  
Küchenarmatur



07258



## Val v72

Sanitary kitchen mixer  
Küchenarmatur



07259



## Classic c20

Sanitary kitchen mixer  
Küchenarmatur



05154



06156



06158

## Classic c71

Sanitary kitchen mixer  
Küchenarmatur



05252



## Classic c72

Sanitary kitchen mixer  
Küchenarmatur



05253



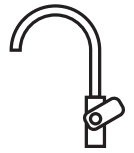

**Classic c70**

Sanitary kitchen mixer  
Küchenarmatur



05251



**Classic c75**

Sanitary kitchen mixer  
Küchenarmatur



06251

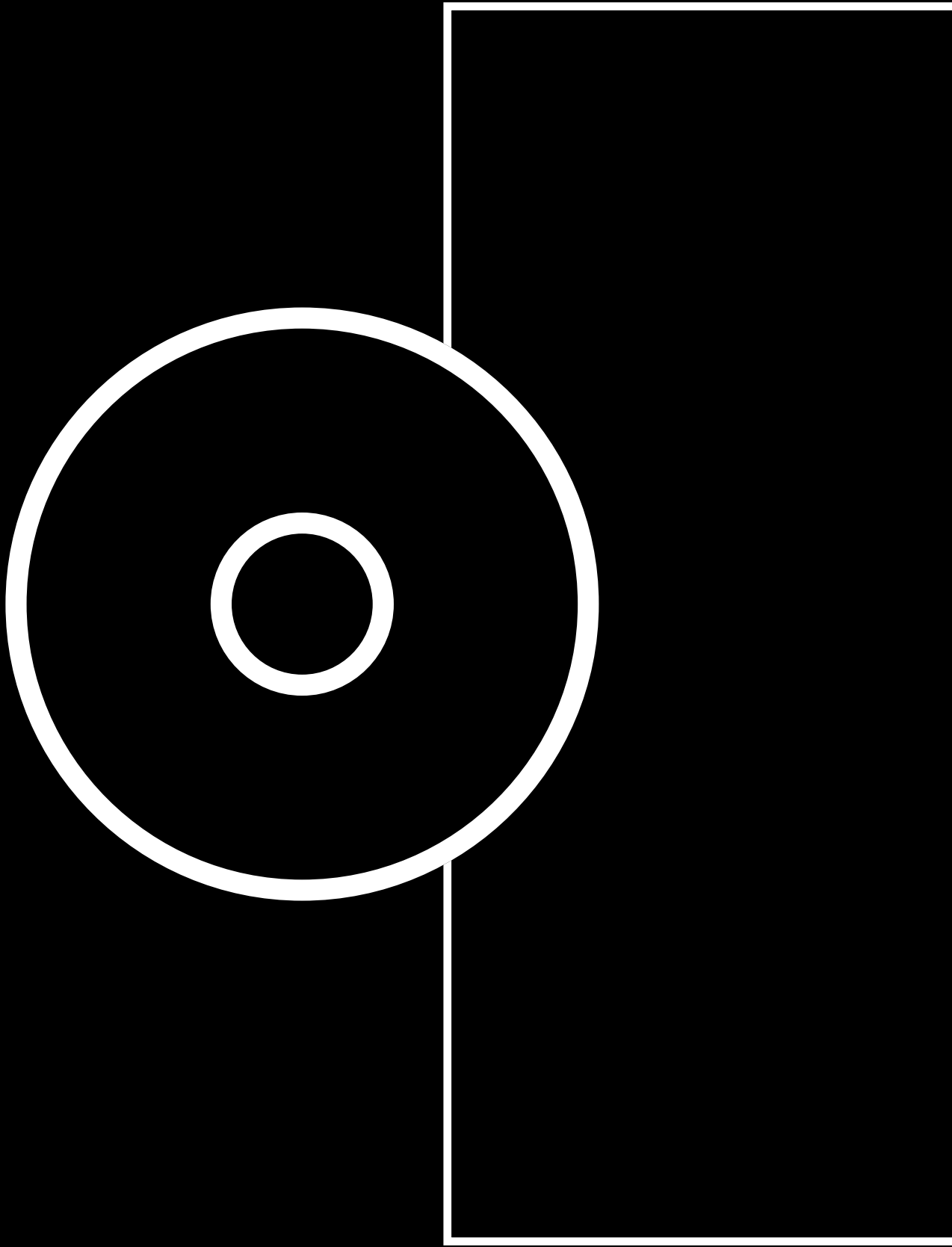

CONCEALED  
MIXERS  
UNTERPUTZ -  
ARMATUREN

# CONCEALED MIXERS UNTERPUTZ - ARMATUREN



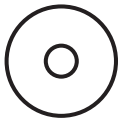

## Elite e90

Rosette and handle for  
concealed shower mixer  
Sichtteil für  
Unterputz-Einhebelmischer



12246

Note: compatible with  
concealed shower mixer  
00367  
Anmerkung: kompatibel mit  
Unterputz-Duscharmatur  
00367

## Elite e91

Rosette and handle for concealed  
mixer for the tub or 2 showers  
Sichtteil für Unterputz-  
Einhebelmischer für die Wanne  
oder 2 Duschen



12247

Note: compatible with  
concealed bath/shower mixer  
or mixer for two showers  
00368  
Anmerkung: kompatibel  
mit Unterputz-Wannen-/  
Duscharmatur oder für zwei  
Duschen 00368

## Elite e90B

Rosette and handle for  
concealed shower mixer  
Sichtteil für  
Unterputz-Einhebelmischer



12246B

Note: compatible with  
concealed shower mixer  
00367B  
Anmerkung: kompatibel mit  
Unterputz-Duscharmatur  
00367B

## Elite e91B

Rosette and handle for concealed  
mixer for the tub or 2 showers  
Sichtteil für Unterputz-  
Einhebelmischer für die Wanne  
oder 2 Duschen



12247B

Note: compatible with  
concealed bath/shower  
mixer or mixer for two  
showers 00368B  
Anmerkung: kompatibel  
mit Unterputz-Wannen-/  
Duscharmatur oder für zwei  
Duschen 00368B



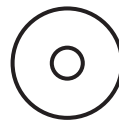

## SQ q90

Set of rosette, handle and concealed shower mixer\*  
Set bestehend aus Sichtteil mit Einhebelmischer und Unterputz-Duscharmatur \*



00361



## SQ q91

Set of rosette, handle and concealed mixer for the tub or 2 showers\*  
Set bestehend aus Sichtteil mit Einhebelmischer und Unterputz-Duscharmatur für Wanne oder 2 Duschen\*



00362



## SQ q90B

Set of rosette, handle and concealed shower mixer\*  
Set bestehend aus Sichtteil mit Einhebelmischer und Unterputz-Duscharmatur \*



00361B



## SQ q91B

Set of rosette, handle and concealed mixer for the tub or 2 showers\*  
Set bestehend aus Sichtteil mit Einhebelmischer und Unterputz-Duscharmatur für Wanne oder 2 Duschen\*



00362B



\*set

## Fresh f90

Rosette and handle  
for concealed shower mixer  
Sichtteil für Unterputz-  
Einhebelmischer



12259



Note: compatible with concealed shower mixer 00367  
Anmerkung: kompatibel mit Unterputz-Duscharmatur 00367

## Fresh f91

Rosette and handle for concealed  
mixer for the tub or 2 showers  
Sichtteil für Unterputz-  
Einhebelmischer für die  
Wanne oder 2 Duschen



12260



Note: compatible with concealed bath/shower mixer or  
mixer for two showers 00368  
Anmerkung: kompatibel mit Unterputz-Wannen-/  
Duscharmatur oder für zwei Duschen 00368

## Project m90

Rosette and handle  
for concealed shower mixer  
Sichtteil für Unterputz-  
Einhebelmischer



12251



Note: compatible with concealed shower mixer 00367  
Anmerkung: kompatibel mit Unterputz-Duscharmatur 00367

## Project m91

Rosette and handle for concealed  
mixer for the tub or 2 showers  
Sichtteil für Unterputz-  
Einhebelmischer für die  
Wanne oder 2 Duschen



12252



Note: compatible with concealed bath/shower mixer or  
mixer for two showers 00368  
Anmerkung: kompatibel mit Unterputz-Wannen-/  
Duscharmatur oder für zwei Duschen 00368

## Infinity i90

Rosette and handle  
for concealed shower mixer  
Sichtteil für Unterputz-  
Einhebelmischer



12249



Note: compatible with concealed shower mixer 00367  
Anmerkung: kompatibel mit Unterputz-Duscharmatur 00367

## Infinity i91

Rosette and handle  
for concealed mixer  
for the tub or 2 showers  
Sichtteil für Unterputz-  
Einhebelmischer für die  
Wanne oder 2 Duschen



12250



Note: compatible with concealed bath/shower mixer or  
mixer for two showers 00368  
Anmerkung: kompatibel mit Unterputz-Wannen-/  
Duscharmatur oder für zwei Duschen 00368

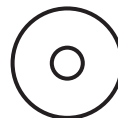

## Box b90

Concealed shower mixer  
Unterputz-Duscharmatur



00367



Note: entrance 2 x 1/2",  
exit 1 x 1/2", fitted casing only,  
for ø35 cartridge  
Anmerkung: Eingang 2 x 1/2",  
Ausgang 1 x 1/2",  
nur Einbaugehäuse,  
für ø35 Kartusche

## Box b91

Concealed bath/shower mixer  
or mixer for two showers  
Unterputz-Wannen-/  
Duscharmatur oder für zwei  
Duschen



00368



Note: entrance 2 x 1/2",  
exit 1 x 1/2", fitted casing only,  
for ø35 cartridge  
Anmerkung: Eingang 2 x 1/2",  
Ausgang 1 x 1/2",  
nur Einbaugehäuse,  
für ø35 Kartusche

## Box b90B

Concealed shower mixer  
Unterputz-Duscharmatur



00367B



Note: entrance 2 x 1/2",  
exit 1 x 1/2", fitted casing only,  
for ø35 cartridge  
Anmerkung: Eingang 2 x 1/2",  
Ausgang 1 x 1/2",  
nur Einbaugehäuse, für ø35

## Box b91B

Concealed bath/shower  
mixer or mixer for two showers  
Unterputz-Wannen-/  
Duscharmatur oder für zwei  
Duschen



00368B



Note: entrance 2 x 1/2",  
exit 1 x 1/2", fitted casing only,  
for ø35 cartridge  
Anmerkung: Eingang 2 x 1/2",  
Ausgang 1 x 1/2",  
nur Einbaugehäuse, für ø35

## Fresh termo f91

Concealed thermostatic basin mixer  
Unterputz-thermostatisch-  
Waschtischbatterie

**NEW**



00399



Note: 19175 – extension option  
Anmerkung: 19175 - Verlängerungsoption

## Infinity i92

Concealed part, rosette  
and handle set  
Unterputzteil, Rosette  
und Bediengriff



00365

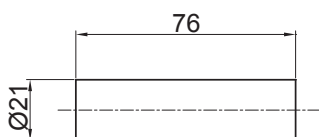

## 12701 12701B

Extension 25 mm for mixer  
Verlängerung 25 mm für Armatur

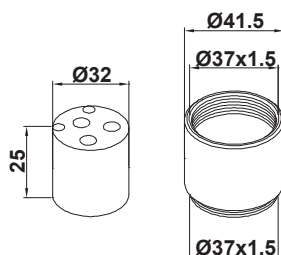

## 12703 12703B

Extension 25 mm for mixer  
Verlängerung 25 mm für Armatur

Note: 12701 for product 00368 and 12701B for  
product 00368B  
Anmerkung: 12701 für Produkt 00368 und  
12701B für Produkt 00368B

Note: 12703 for product 00367 and 00368,  
12703B for product 00367B and 00368B  
Anmerkung: 12703 für Produkt 00367 und  
00368, 12703B für Produkt 00367B und 00368B



## Lino I90

Rosette and handle  
for concealed shower mixer  
Sichtteil für  
Unterputz-Einhebelmischer

**NEW**



12268

Note: compatible with concealed  
shower mixer 00367  
Anmerkung: kompatibel mit  
Unterputz-Duscharmatur 00367

149

## Lino I91

Rosette and handle for concealed  
mixer for the tub or 2 showers  
Sichtteil für  
Unterputz-Einhebelmischer  
für die Wanne oder 2 Duschen

**NEW**



12269

Note: compatible with concealed  
shower mixer 00368  
Anmerkung: kompatibel mit  
Unterputz-Duscharmatur 00368



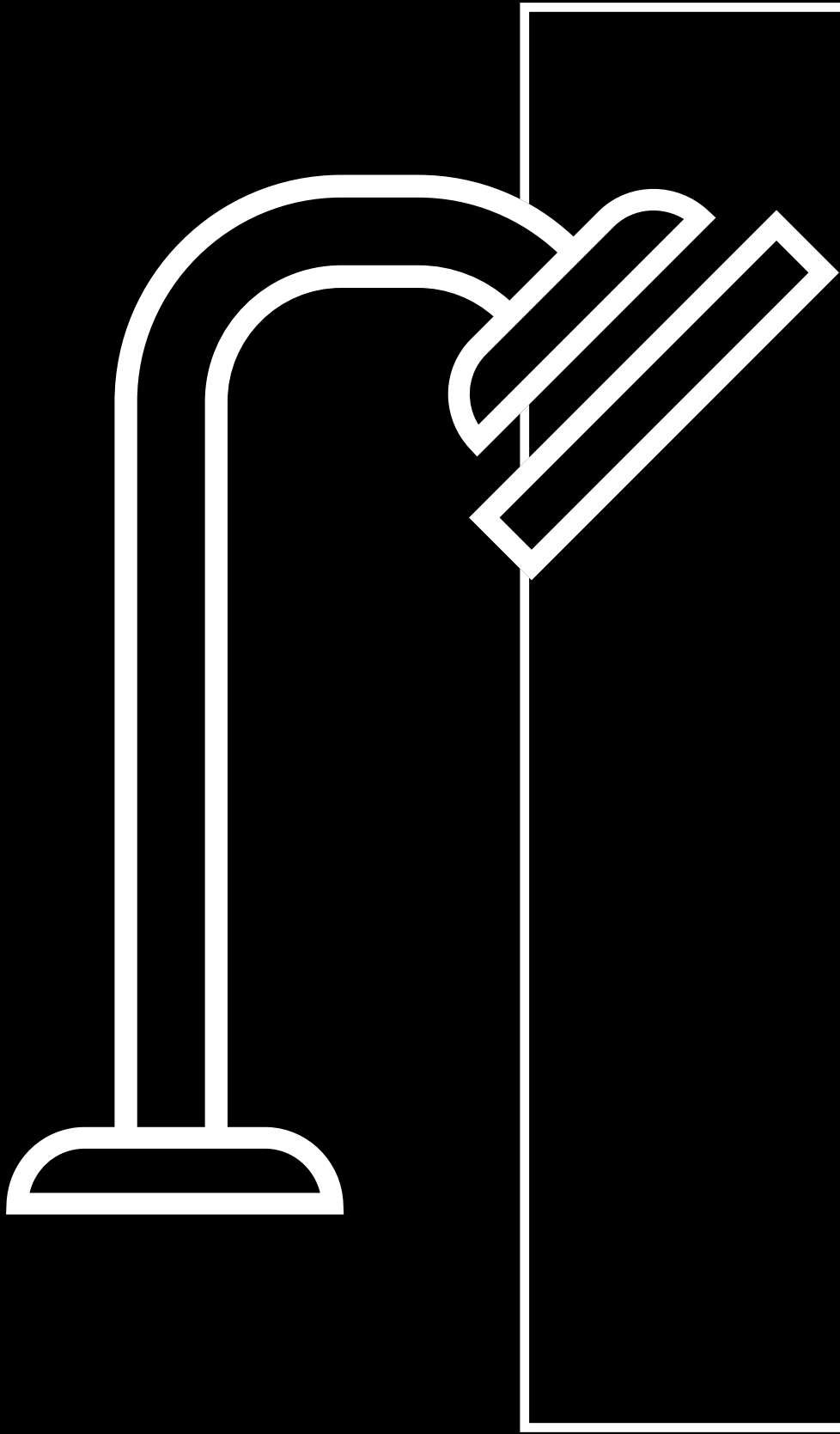

SHOWERS  
DUSCHEN

# SHOWERS DUSCHEN





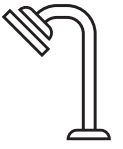

# HEAD SHOWER KOPFBRAUSE

**a200B**  
Head shower  
Kopfbrause



12112B



Note : 200 x 200 mm, ABS  
Anmerkung: 200 x 200 mm, ABS



Note : 200 x 200 mm, ABS  
Anmerkung: 200 x 200 mm, ABS

**a200**  
Head shower  
Kopfbrause



12112

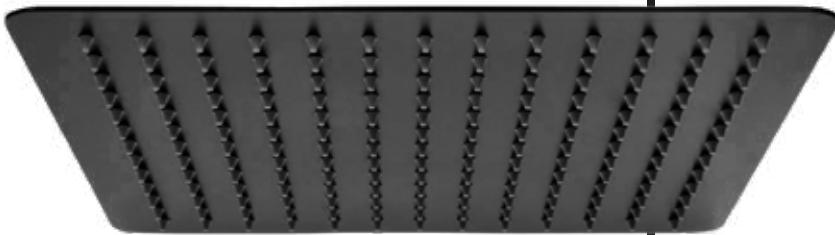

## a201B

Head shower  
Kopfbrause

**NEW**



12114B

Note : 300x300mm, INOX  
Anmerkung:300x300mm, INOX

## a206

Head shower  
Kopfbrause



12109



Note: 300 x 300 mm, Brass  
Anmerkung: 300 x 300 mm, Messing

## a204

Head shower  
Kopfbrause



12108



Note: 250 x 250 mm, ABS  
Anmerkung: 250 x 250 mm, ABS

## a205

Head shower - chrome  
Kopfbrause - chrom



12110



Note: 250 x 250 mm, ABS  
Anmerkung: 250 x 250 mm, ABS



Note: Ø 200 mm, Medenina  
Anmerkung: Ø 200 mm, Messing

## a202

Head shower  
Kopfbrause



12104

157

## a202B

Head shower  
Kopfbrause

**NEW**



12113B



Note: Ø200mm, ABS  
Anmerkung: Ø200mm, ABS

# a207

Wall shower  
Wandbrause



12103



Note: Ø 227 mm, ABS  
Anmerkung: Ø 227 mm, ABS

# a207\*

Wall shower - white  
Wandbrause - weiß



12107



Note: Ø 227 mm, ABS  
Anmerkung: Ø 227 mm, ABS

\*White/weiß



Note: 260 x 200 mm, ABS  
Anmerkung: 260 x 200 mm, ABS

## a203

Wall shower  
Wandbrause



12106

## a208

Wall shower 1/2"  
Wandbrause 1/2"



12101

Note: Ø 76 x 85 mm  
Anmerkung: Ø 76 x 85 mm

## a209

Wall shower 1/2"  
Wandbrause 1/2"



12102

Note: Ø 85 mm  
Anmerkung: Ø 85 mm

# SHOWER HEADS BRAUSEKÖPFE



Note: 3 sprays  
Anmerkung: 3-fach verstellbarer Wasserstrahl

Note: 3 sprays  
Anmerkung: 3-fach verstellbarer Wasserstrahl

\* Shower hose not included!  
\* Duschschlauch ist separat zu bestellen!





**a303**

Shower head\*  
Brausekopf\*



12057



**a304**

Shower head\*  
Brausekopf\*



12050

Note: 3 sprays  
Anmerkung: 3-fach verstellbarer Wasserstrahl

Note: 3 sprays  
Anmerkung: 3-fach verstellbarer Wasserstrahl



**a305B**

Shower head\*  
Brausekopf\*

**NEW**



12058B

Note: 3 sprays  
Anmerkung: 3-fach verstellbarer Wasserstrahl

\* Shower hose not included!

\* Duschschlauch ist separat zu bestellen!



## a306

Shower head, hose and wall holder  
Brausekopf, Brauseschlauch und Wandhalterung



12352



## a307

Shower head\*  
Brausekopf\*



12043

Note: shower set  
Anmerkung: Brauseset



## a308

Shower head, hose and wall holder  
Brausekopf, Brauseschlauch und Wandhalterung



12357

Note: shower set  
Anmerkung: Brauseset



## a309

Shower head\*  
Brausekopf\*



12047

\* Shower hose not included!  
\* Duschschlauch ist separat zu bestellen!



## a310

Shower head, hose and wall holder  
Brausekopf, Brauseschlauch und Wandhalterung



12351



## a311

Shower head\*  
Brausekopf\*



12044



Note: shower set / Anmerkung: Brauseset

## a312

Shower head, hose and wall holder  
Brausekopf, Brauseschlauch und Wandhalterung



12358



## a313

Shower head\*  
Brausekopf\*



12042



Note: shower set / Anmerkung: Brauseset

## a314

Shower head, hose and wall holder  
Brausekopf, Brauseschlauch und Wandhalterung



12354



## a315

Shower head\*  
Brausekopf\*



12041



Note: shower set / Anmerkung: Brauseset

## a316

Shower head - white  
Brausekopf weiß



19088



\* Shower hose not included!

\* Duschschlauch ist separat zu bestellen.



SHOWERSYSTEM  
DUSCHSYSTEMS

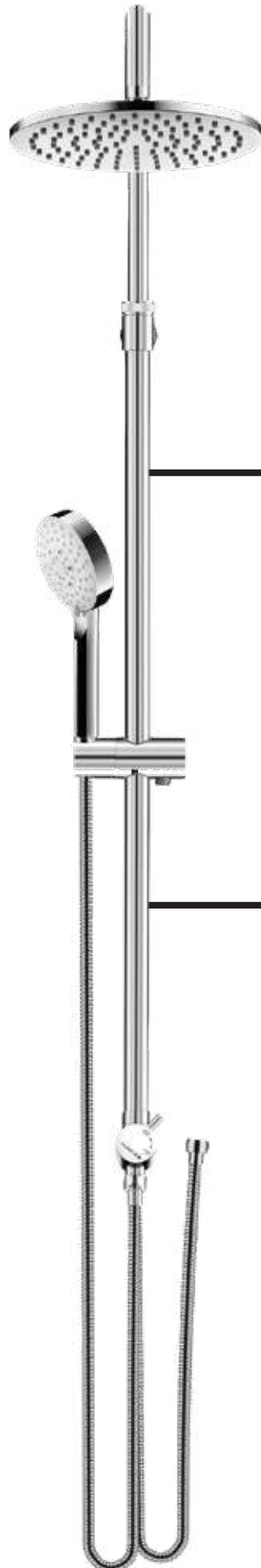

**a406**

Shower system  
Duschsystem



12551

# SHOWERSYSTEM DUSCHSYSTEMS

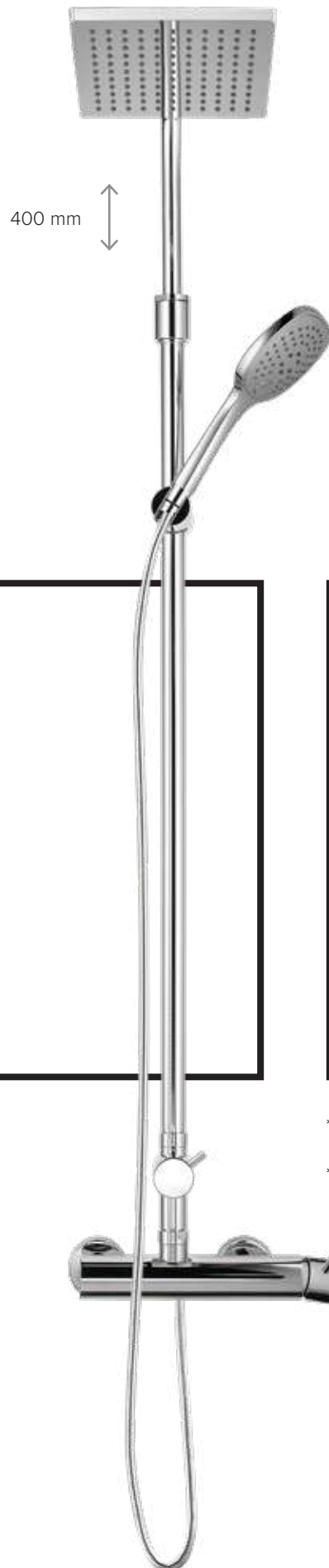

## Fresh f150

Shower system\*  
Duschsystem\*



00444

- \* Option to buy only the fittings 00446
- \* Option, nur die Armatur 00446 zu kaufen

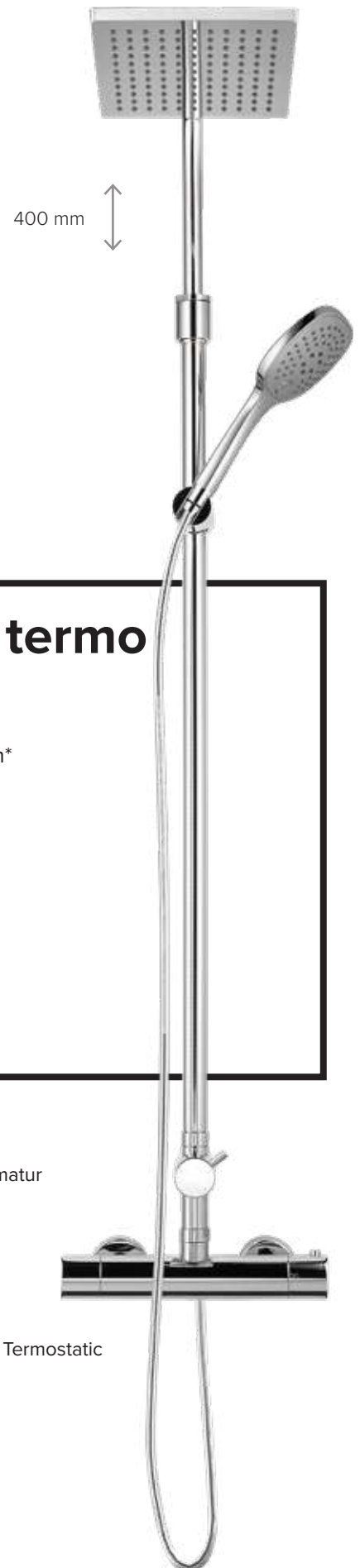

## Fresh termo f150

Shower system\*  
Duschsystem\*



00443

- \* Option to buy only the fittings 00445
- \* Option, nur die Armatur 00445 zu kaufen

Thermostatic



400 mm



400 mm

## Fresh f151

Shower system\*  
Duschsystem\*



00442

## Fresh termo f151

Shower system\*  
Duschsystem\*



00441

\* Option to buy only the fittings 00446  
\* Option, nur die Armatur 00446 zu kaufen

\* Option to buy only the fittings 00445  
\* Option, nur die Armatur 00445 zu kaufen

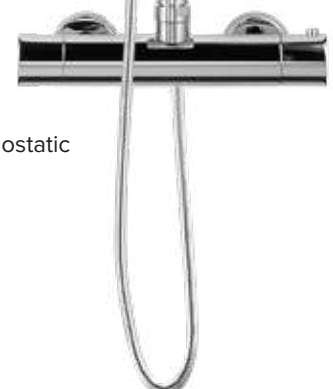

Termostatic

# SHOWER SETS DUSCHSETS



**a400**

Shower set with shower rail  
Duschset mit Brausestange



12455\* 12456

\* version chrome - gold  
\* Ausführung Chrom - Gold  
Note: Shower set, Brass  
Anmerkung: Brauseset, messing



**a401**

Shower set with  
shower rail  
(max 690mm)  
Duschset mit  
Brausestange  
(max 690mm)



12457

Note: Shower set, ABS  
Anmerkung: Brauseset, ABS





**a402**

Shower set with shower rail  
Duschset mit Brausestange



12463

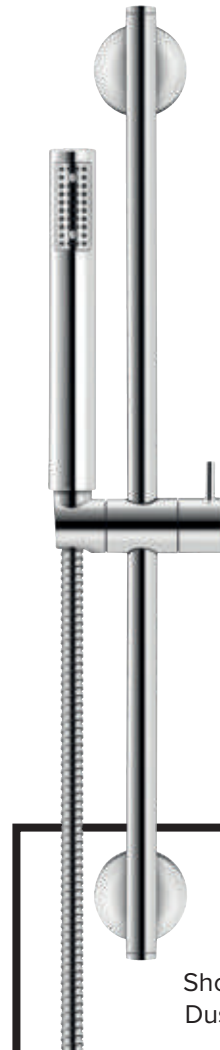

**a403**

Shower set with shower rail  
Duschset mit Brausestange



12452

Note: Shower rail  $\varnothing$  24 mm, Brass  
Anmerkung: Brausestange  $\varnothing$  24 mm, Messing

Note: Shower rail  $\varnothing$  18 mm, Brass  
Anmerkung: Brausestange  $\varnothing$  18 mm, Messing



### a404

Shower set with shower rail  
Duschset mit Brausestange



12460

Note: Shower rail Ø 25 mm, ABS  
Anmerkung: Brausestange Ø 25 mm, ABS



### a405

Shower set with shower rail  
Duschset mit Brausestange



12461

Note: Shower rail Ø 24 mm, ABS  
Anmerkung: Brausestange Ø 24 mm, ABS



**a407**

Shower set with  
shower rail  
Duschset mit  
Brausestange



12464

Note: Shower rail, ABS  
Anmerkung: Brausestange, ABS



**a407B**

Shower set with  
shower rail  
Duschset mit  
Brausestange



12464B

Note: Shower rail, ABS  
Anmerkung: Brausestange, ABS



## Fresh f192

Concealed basin mixer  
with shut-off set  
Unterputz Waschtischbatterie  
mit shut-off set

**NEW**

SET

00359

## Fresh f192B

Concealed basin mixer  
with shut-off set  
Unterputz Waschtischbatterie  
mit shut-off set

**NEW**

SET

00359B



## a408

Shut-off set with  
wall - holder  
Ein-/Ausschaltung mit  
Wandhalterung

**NEW**

SET

12361

# CONCEALED SHOWERS SYSTEMS VERDECKTE DUSCHSYSTEME



**Fresh termo  
f191**

**NEW**

SET

00379



Head shower  
Kopfbrause

Wall shower holder 1/2"  
Wandbrausehalter 1/2"



Set of rosette, handle and  
concealed mixer for the tub  
or 2 showers  
Set bestehend aus Sichtteil  
mit Einhebelmischer und  
Unterputz-Duscharmatur für  
Wanne oder 2 Duschen



Concealed thermostatic  
basin mixer  
Unterputz-  
thermostatisch-  
Waschtischbatterie



Shower hose  
Brauseschlauch



Shower head  
Brausekopf



Wall shower connection 1/2"  
Wandbrauseanschluss 1/2"

# Elite e191B

**NEW**

SET

00377B



Head shower  
Kopfbrause

Wall shower holder 1/2"  
Wandbrausehalter 1/2"



Shower hose  
Brauseschlauch



Set of rosette, handle and  
concealed mixer for the tub  
or 2 showers  
Set bestehend aus Sichtteil  
mit Einhebelmischer und  
Unterputz-Duscharmatur für  
Wanne oder 2 Duschen



Shower head  
Brausekopf



Wall shower connection and shower holder 1/2"  
Wandbrauseanschluss und Brausehalter 1/2"



# Elite e191

SET

00377



Head shower  
Kopfbrause

Wall shower holder 1/2"  
Wandbrausehalter 1/2"



Set of rosette, handle and concealed mixer for the tub or 2 showers  
Set bestehend aus Sichtteil mit Einhebelmischer und Unterputz-Duscharmatur für Wanne oder 2 Duschen



Shower hose  
Brauseschlauch

175



Wall shower connection and shower holder 1/2"  
Wandbrauseanschluss und Brausehalter 1/2"



Shower head  
Brausekopf

**SQ  
q191B**

SET

00364B



Head shower  
Kopfbrause

Wall shower holder 1/2"  
Wandbrausehalter 1/2"



Shower hose  
Brauseschlauch



Set of rosette, handle and concealed mixer for the tub or 2 showers  
Set bestehend aus Sichtteil mit Einhebelmischer und Unterputz-Duscharmatur für Wanne oder 2 Duschen



Shower head  
Brausekopf



Wall shower connection and shower holder 1/2"  
Wandbrauseanschluss und Brausehalter 1/2"





**SQ  
q191**

SET

00364



Head shower  
Kopfbrause

Wall shower holder 1/2"  
Wandbrausehalter 1/2"



Set of rosette, handle and concealed mixer for the tub or 2 showers  
Set bestehend aus Sichtteil mit Einhebelmischer und Unterputz-Duscharmatur für Wanne oder 2 Duschen



Shower hose  
Brauseschlauch



Wall shower holder 1/2"  
Wandbrausehalter 1/2"



Shower head  
Brausekopf

# Infinity i191

SET

00371

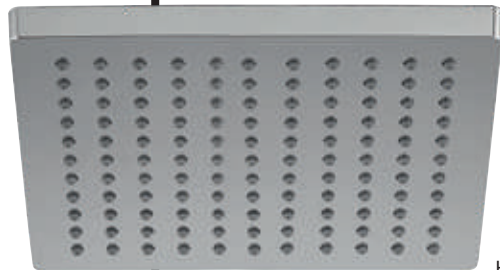

Head shower  
Kopfbrause

Wall shower holder 1/2"  
Wandbrausehalter 1/2"



Shower hose  
Brauseschlauch



Set of rosette, handle and concealed mixer for the tub or 2 showers  
Set bestehend aus Sichtteil mit Einhebelmischer und Unterputz-Duscharmatur für Wanne oder 2 Duschen



Shower head  
Brausekopf

Wall shower connection 1/2"  
Wandbrauseanschluss 1/2"



Wall shower holder  
Wandhalterung für Brause





Head shower  
Kopfbrause

Wall shower holder 1/2"  
Wandbrausehalter 1/2"



Set of rosette, handle and concealed mixer for the tub or 2 showers  
Set bestehend aus Sichtteil mit Einhebelmischer und Unterputz-Duscharmatur für Wanne oder 2 Duschen



Shower hose  
Brauseschlauch

Wall shower connection 1/2"  
Wandbrauseanschluss 1/2"



Wall shower holder  
Wandhalterung für Brause



Shower head  
Brausekopf

# Infinity i192

SET

00363



Rosete and handle for  
concealed shower mixer  
Sichtteil für Unterputz -  
Einhebelmischer

Concealed shower mixer  
Unterputz - Duscharmatur



Shower hose  
Brauseschlauch

Wall shower connection and  
shower holder 1/2"  
Wandbrauseanschluss 1/2"



Shower head  
Brausekopf

# SHOWER ACCESSORIES BRAUSEZUBEHÖR



## a600

Shower hose  
Brauseschlauch

800  
mm

1500  
mm

2000  
mm

12003

12001

19038

## a601

Shower hose  
Brauseschlauch

1500  
mm

2000  
mm

12002

12004

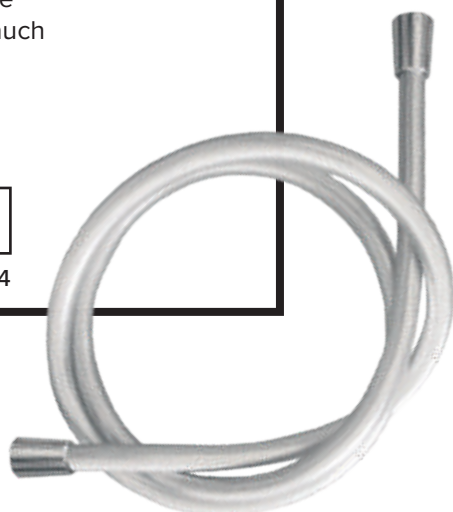

## a601B

Shower hose  
Brauseschlauch

1500  
mm

12005B



## a700

Wall shower holder 1/2"  
wandbrausehalter 1/2"



12212

Note: 375 mm  
Anmerkung: 375 mm

## a700B

Wall shower holder 1/2"  
wandbrausehalter 1/2"



12212B

Note: 375 mm  
Anmerkung: 375 mm

## a701

Wall shower holder 1/2"  
wandbrausehalter 1/2"



12208

Note: 414 mm  
Anmerkung: 414 mm

## a702B

Wall shower holder 1/2"  
wandbrausehalter 1/2"

**NEW**



12216B

Note: 375 mm  
Anmerkung: 375 mm



Note: 155 mm  
Anmerkung: 155 mm



Note: 150 mm  
Anmerkung: 150 mm



Note: 420 mm  
Anmerkung: 420 mm

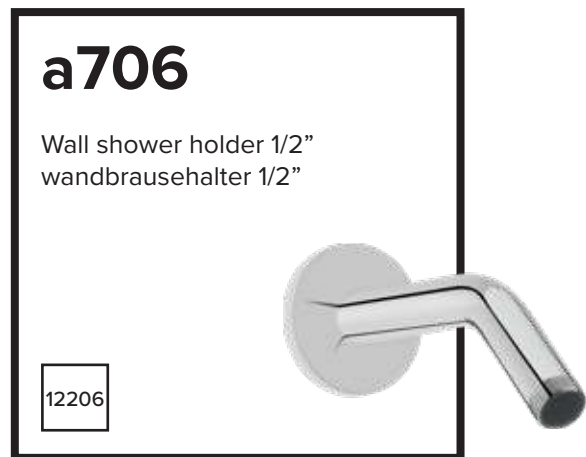

Note: 108 mm  
Anmerkung: 108 mm

## a900

Bath spout 1/2"  
Wannenauslauf 1/2"



12201

Note: 150 mm  
Anmerkung: 150 mm

## a901

Bath spout 1/2"  
Wannenauslauf 1/2"



12202

Note: 180 mm  
Anmerkung: 180 mm

## a902

Bath spout 1/2"  
Wannenauslauf 1/2"



12211

Note: 180 mm  
Anmerkung: 180 mm

## a800

Wall shower connection  
and shower holder 1/2"  
Wandbrauseanschluss  
und Brausehalter 1/2"



12213

Note: 108 mm  
Anmerkung: 108 mm

## a801

Wall shower connection  
and shower holder 1/2"  
Wandbrauseanschluss  
und Brausehalter 1/2"



12214

## a802

Wall shower holder  
Wandhalterung für Brause



12215





### a803B

Wall shower connection  
and shower holder 1/2"  
Wandbrauseanschluss  
und Brausehalter 1/2"



12218B

Note: Brass  
Anmerkung: Messing

### a804B

Wall shower connection 1/2"  
Wandbrauseanschluss 1/2"



12217B

Note: Brass  
Anmerkung: Messing

### a805B

Wall shower holder  
Wandhalterung für Brause



12219B

Note: ABS  
Anmerkung: ABS

### a800B

Wall shower connection  
and shower holder 1/2"  
Wandbrauseanschluss  
und Brausehalter 1/2"



12213B

Note: Brass  
Anmerkung: Messing

### a801B

Wall shower connection 1/2"  
Wandbrauseanschluss 1/2"



12214B

Note: Brass  
Anmerkung: Messing

### a802B

Wall shower holder  
Wandhalterung für Brause



12215B

Note: ABS  
Anmerkung: ABS

## a806

Wall shower connection 1/2"  
Wandbrauseanschluss 1/2"

12203



## a807

Wall shower connection 1/2"  
Wandbrauseanschluss 1/2"

12204



## a808

Wall shower connection 1/2"  
Wandbrauseanschluss 1/2"

12210



## a809

Wall shower holder  
Wandhalterung für Brause

12154

12155\*



\* Version chrome - gold  
\* Ausführung Chrom - Gold

## a810

Wall shower holder  
Wandhalterung für Brause

12151



## a811

Wall shower holder  
Wandhalterung für Brause

12152



## a812

Wall shower holder  
Wandhalterung für Brause

12153





**a500**  
Shower rail  
Brausestange



12659

**a500B**  
Shower rail  
Brausestange



12659B

**a501B**  
Shower rail  
Brausestange



12660B

**a502**  
Shower rail  
Brausestange



12651

**a503**  
Shower rail  
Brausestange



12652

**a504**  
Shower rail  
Brausestange



12653 12654\*

\* Version  
chrome - gold  
\* Ausführung  
Chrom - Gold

**a505**  
Shower rail  
Brausestange



12655

**a506**  
Shower rail  
Brausestange



12657

max. 690 mm

**a507**  
Shower rail  
Brausestange



19052

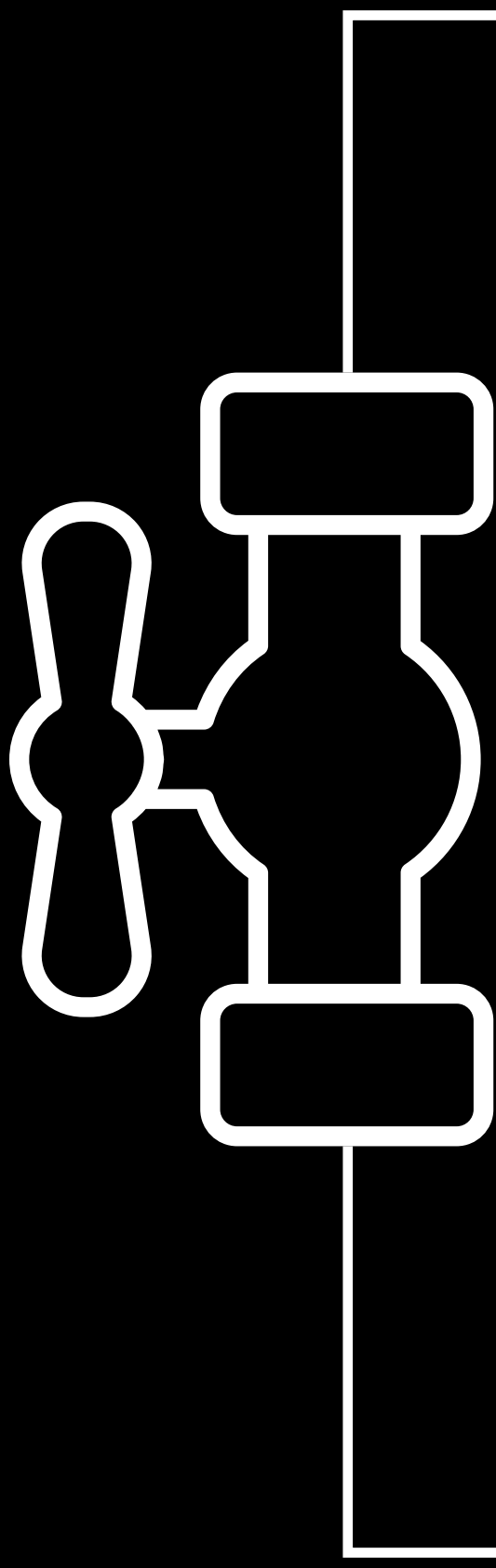

ACCESSORIES  
ZUBEHÖR

# SIPHONS

## SIPHON

### 16009B

Click clack Siphon for basin Black universal G1 1/4"

Click clack  
Universalsiphon für  
Waschbecken Black  
G1 1/4"



Note: Brass  
Anmerkung: Messing

### 16006

Click clack Siphon for basin with overflow G1 1/4"  
Click clack Siphon mit Überlauf für Waschbecken G1 1/4"



Note: ABS  
Anmerkung: ABS

### 16007

Click clack Siphon for basin without overflow G1 1/4"

Click clack Siphon ohne Überlauf für Waschbecken G1 1/4"



Note: Brass  
Anmerkung: Messing

### 16008

Click clack Siphon for basin with overflow G1 1/4"  
Click clack Siphon mit Überlauf für Waschbecken G1 1/4"



Note: Brass  
Anmerkung: Messing

### 16207B

Siphon for basin Black G 1 1/4"  
Siphon für Waschbecken Black G 1 1/4"



Note: extension can be bought 16208B  
Anmerkung: Verlängerung kann separat gekauft werden 16208B

### 16207

Siphon for basin G 1 1/4"  
Siphon für Waschbecken G 1 1/4"





## 16206

Siphon for basin G 1 1/4"  
Siphon für Waschbecken G 1 1/4"



## 16306

Siphon set for basin G 1 1/4"  
Siphon-Set für Waschbecken G 1 1/4"



## 16202

Siphon set for bidet G 1 1/4"  
Siphon-Set für Bidet G 1 1/4"

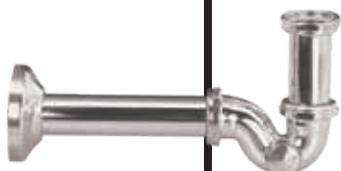

## 16302

Siphon set for basin G 1 1/4"  
Siphon-Set für Waschbecken G 1 1/4"



## 16303

Siphon set for bidet G 1 1/4"  
Siphon-Set für Bidet G 1 1/4"



## 16305

Siphon set for basin G 1 1/4"  
Siphon-Set für Waschbecken G 1 1/4"



## 16005

Draining valve with siphon  
Ablaufgarnitur mit Siphon



## 16201

Siphon for basin G 1 1/4"  
Siphon für Waschbecken G 1 1/4"



## 16204

Siphon for urinal G 1 1/4"  
Siphon für Urinal G 1 1/4"



## 16301

Siphon set for basin G 1 1/4"  
Siphon-Set für  
Waschbecken G 1 1/4"



## 19253

Siphon plug  
Siphonstopfen





# VALVES VENTILE

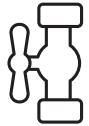

## 13112

Angle ball valve  
for urinal G 1/2" - 3/8"  
Kugel Eckventil  
für Urinal G 1/2" - 3/8"

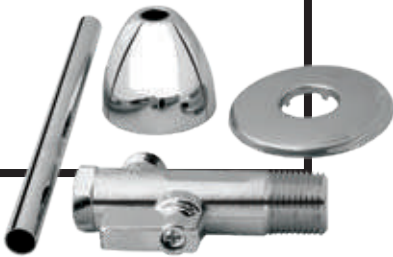

## 13113

Angle ball valve  
with filter G 1/2" - 3/8"  
Kugel Eckventil  
mit Filter G 1/2" - 3/8"

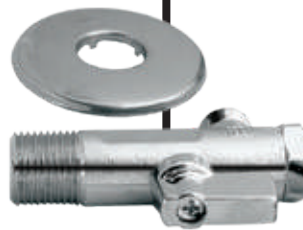

## 19433

Diverter G 1/2" - 3/8"  
Umschalter G 1/2" - 3/8"



## UH16004

Angle valve G 1/2" - 3/8"  
Eckventil G 1/2" - 3/8"



## 13001 1/2" 13002 3/4"

Safety valve 8 bars  
Sicherheitsventil 8 bar



## 13003 1/2" 13004 3/4"

Safety valve 10 bars  
Sicherheitsventil 10 bar



## 13301

Opening valve  
G 1/2" - 1/2"  
Durchgangsventil  
G 1/2" - 1/2"



## 13401

Opening valve  
G 1/2" - 1/2"  
Durchgangsventil  
G 1/2" - 1/2"



## 2 4215 61

Closing valve  
G 1/2" - 3/4"  
Absperrventil  
G 1/2" - 3/4"

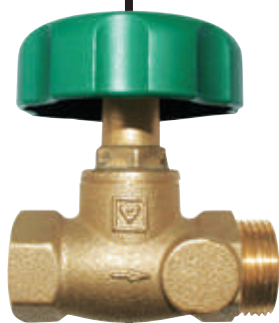

## 2 77665 4

Thermostatic mixing valve  
for drinking water  
G 3/4" - 3/4"  
Thermostatischer  
Mischventil für Trinkwasser  
G 3/4" - 3/4"



## 16001

Draining valve G 1 1/4"  
Ablaufventil G 1 1/4"



## 16002

Draining valve G 1 1/4"  
Ablaufventil G 1 1/4"



# ACCESSORIES ZUBEHÖR

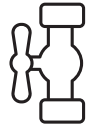

## 19001

Connection tubes  
300/350 mm  
Verbindungsschläuche  
300/350 mm

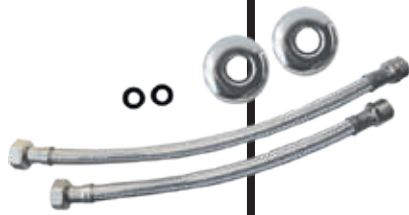

## 19021

Connection tubes  
Ø 10x440  
Verbindungsrohre  
Ø 10x440



## 19022

Connection tubes  
Ø 10x422, nut 1/2"  
Verbindungsrohre  
Ø 10x422, Mutter 1/2"



## 19023

Connection tubes  
Ø 10x422, nut 3/8"  
Verbindungsrohre  
Ø 10x422, Mutter 3/8"

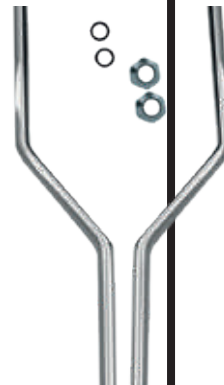

## 19110

Set for water conservation  
3-piece  
Set zur Wassereinsparung  
3-teilig



Note: Set includes 2 ECO aerators with water flow 6l/min and water flow regulator with water flow of 9 l/minute. It could be used at all ranges HERZ.

Anmerkung: Das Set enthält 2 Eco-Perlatoren mit einem Wasserdurchfluss von 6 l/min und einen Wasserdurchflussregler mit einem Wasserdurchfluss von 9 l/min. Es kann in allen HERZ Programmen verwendet werden.

## 19132

Spout "S" Ø 13x200 mm  
Auslauf "S" Ø 13x200 mm



## 19133

Spout "S" Ø 13x300 mm  
Auslauf "S" Ø 13x300 mm



## 19145

Spout "S" Ø 18x250 mm  
Auslauf "S" Ø 18x250 mm



## 19204

Flat spout  
Flacher Auslauf  
(l=120mm)



## 19209

Flat spout  
Flacher Auslauf  
(l=200mm)



## 19216

Flat spout  
Flacher Auslauf  
(l=300 mm)





## 19219

Mat  
Sockel



## 19379

Medical handle  
Medizinischer Handgriff



Note: for products: Infinity 00004 in Elite 00088  
Anmerkung: für Produkte: Infinity 00004 i Elite 00088

Note: length of handle 200 mm  
Anmerkung: länge des Griffs 200 mm

## 19504

Reduction nut with seals  
Reduziermutter mit Dichtung



## 21001

Rosette 3/4"  
Rosette 3/4"



Note: G1/2 - G3/4  
Anmerkung: G1/2 - G3/4

## 21002

Rosette 3/4"  
Rosette 3/4"



## 21161

S- union with noise reduction  
Exzenter S mit Schallreduktion



# INDEX

00001	48	00091	72	00201	113	00388	78	00591	72
00002	48	00092	72	00202	113	00389	78	00592	72
00003	48	00093	72	00205	113	00393	73	00594	72
00004	48	00094	72	00208	113	00394	73	00595	31
00006	49	00095	43	00211	113	00395	73	00595B	27
00011	48	00096	42	00237	131	00396	44	00600	58
00012	48	00101	100	00281	130	00399	148	00601	58
00013	48	00101B	98	00282	130	00401	51	01011	48
00014	48	00102	100	00291	127	00402	51	01012	48
00023	74	00103	101	00292	127	00403	51	01035	59
00024	74	00103Ni	99	00301	50	00411	51	01036	59
00025	74	00104	102	00301	52	00425	75	01081	76
00026	74	00105	102	00302	50	00427	75	01082	76
00029	91	00106	103	00303	50	00430	39	01095	72
00030	91	00111	104	00311	50	00430B	37	01096	72
00031	91	00112	104	00325	75	00434	61	01101	100
00033	91	00113	105	00326	75	00435	61	01101B	98
00034	60	00114	106	00330	39	00437	63	01102	102
00035	59	00115	106	00330B	37	00438	61	01107	101
00037	77	00116	107	00334	61	00440	63	01107Ni	99
00038	59	00120	108	00335	61	00441	167	01108	103
00039	59	00121	109	00336	63	00442	167	01120	108
00040	59	00129	121	00337	61	00443	166	01121	109
00042	58	00130	121	00339	63	00444	166	01137	120
00044	60	00131	121	00359	172	00480	79	01138	118
00045	60	00132	121	00359B	172	00481	79	01140	120
00048	58	00133	120	00360	32	00482	79	01141	121
00049	58	00134	120	00360B	28	00485	23	01142	121
00053	48	00135	118	00361	145	00485B	19	01143	121
00057	31	00136	118	00361B	145	00486	23	01144	121
00057B	27	00137	122	00362	145	00487	23	01145	119
00058	30	00138	122	00362B	145	00490	45	01146	119
00058B	26	00144	119	00363	180	00491	73	01164	135
00059	52	00145	119	00364	177	00492	73	01169	112
00060	53	00146	119	00364B	176	00493	73	01171	112
00069	54	00147	119	00365	148	00494	33	01173	114
00070	55	00169	112	00366	179	00494B	29	01175	115
00077	38	00170	112	00367	147	00501	49	01181	130
00077B	36	00171	112	00367B	147	00503	49	01182	128
00078	43	00172	112	00368	147	00515	74	01183	130
00079	20	00173	114	00368B	147	00516	74	01184	128
00080	22	00174	114	00371	178	00518	74	01185	126
00080B	18	00175	115	00373	23	00530	38	01186	129
00081	76	00176	115	00373B	19	00530B	36	01187	129
00082	76	00180	130	00374	23	00535	59	01188	129
00083	76	00181	130	00375	23	00536	59	01189	129
00084	76	00182	128	00377	175	00537	59	01281	131
00085	21	00183	130	00377B	174	00538	59	05055	89
00086	21	00184	126	00379	173	00581	76	05056	89
00087	21	00185	126	00380	78	00582	76	05154	138
00088	21	00186	128	00381	78	00584	76	05251	139
00088B	17	00188	129	00383	77	00586	21	05252	138
00089	20	00189	129	00384	78	00588	21	05253	138
00089B	16	00190	129	00386	77	00588B	17	05351	89
00090	20	00193	129	00387	77	00590	43	05355	89

05451	90	07452	85	10452	90	12214	184	13003 1/2"	193
05452	90	07454	85	10551	87	12214B	185	13004 3/4"	193
05454	90	07462	81	10571	87	12215	184	13112	193
05455	90	07464	83	10651	88	12215B	185	13113	193
05553	89	07465	81	10652	87	12216B	182	13301	194
05554	89	07466	83	10672	87	12217B	185	13401	194
05557	89	07550	84	12001	181	12218B	185	16001	194
06156	138	07553	84	12002	181	12219B	185	16002	194
06158	138	07554	81	12003	181	12220B	183	16005	192
06251	139	07555	83	12004	181	12246	144	16006	190
07053	84	07557	84	12005B	181	12246B	144	16007	190
07055	84	07558	81	12040	160	12247	144	16008	190
07057	84	07559	83	12040B	160	12247B	144	16009B	190
07059	84	08148	136	12041	163	12249	146	16201	192
07060	84	08149	133	12042	163	12250	146	16202	191
07061	80	08150	135	12043	162	12251	146	16204	192
07062	80	08153	136	12044	163	12252	146	16206	191
07063	82	08155	136	12047	162	12259	146	16207	190
07064	82	08161	135	12050	161	12260	146	16207B	190
07065	84	08163	133	12054	160	12261	67	16301	192
07066	80	08166	136	12055	160	12263	67	16302	191
07067	80	08253	136	12057	161	12268	149	16303	191
07068	82	08255	133	12058B	161	12269	149	16305	191
07072	80	08256	135	12101	159	12351	163	16306	191
07073	82	09116	65	12102	159	12352	162	19001	195
07074	84	09117	65	12103	158	12354	163	19021	195
07076	84	09118	66	12104	157	12357	162	19022	195
07077	80	09119	66	12106	159	12358	163	19023	195
07078	82	09120	65	12107	158	12361	172	19038	181
07079	82	09121	65	12108	156	12452	169	19052	187
07153	136	09122	66	12109	155	12455*	168	19088	163
07155	136	09123	66	12110	156	12456	168	19110	195
07156	133	09124	65	12112	154	12457	168	19132	196
07157	133	09125	65	12112B	154	12460	170	19133	196
07158	135	09126	66	12113B	157	12461	170	19145	196
07159	135	09127	66	12114B	155	12463	169	19204	196
07161	136	09510	67	12151	186	12464	171	19209	196
07162	133	09511	67	12152	186	12464B	171	19216	196
07163	135	09512	67	12153	186	12551	165	19219	197
07164	136	09521	68	12154	186	12651	187	19253	192
07165	133	09522	68	12155*	186	12652	187	19379	197
07169	135	10052	86	12201	184	12653	187	19433	193
07257	137	10072	86	12202	184	12654*	187	19504	197
07258	137	10151	86	12203	186	12655	187	19806	69
07259	137	10152	88	12204	186	12657	187	19807	69
07260	132	10171	86	12206	183	12659	187	2 4215 61	194
07261	132	10251	88	12207	183	12659B	187	2 77665 4	194
07262	132	10351	88	12208	182	12660B	187	21001	197
07263	134	10352	86	12209	183	12701	148	21002	197
07264	134	10354	87	12210	186	12701B	148	21161	197
07265	134	10355	88	12211	184	12703	148	UH16004	193
07355	85	10356	88	12212	182	12703B	148		
07356	85	10372	86	12212B	182	12704	69		
07357	81	10374	87	12213	184	13001 1/2"	193		
07358	83	10451	88	12213B	185	13002 3/4"	193		











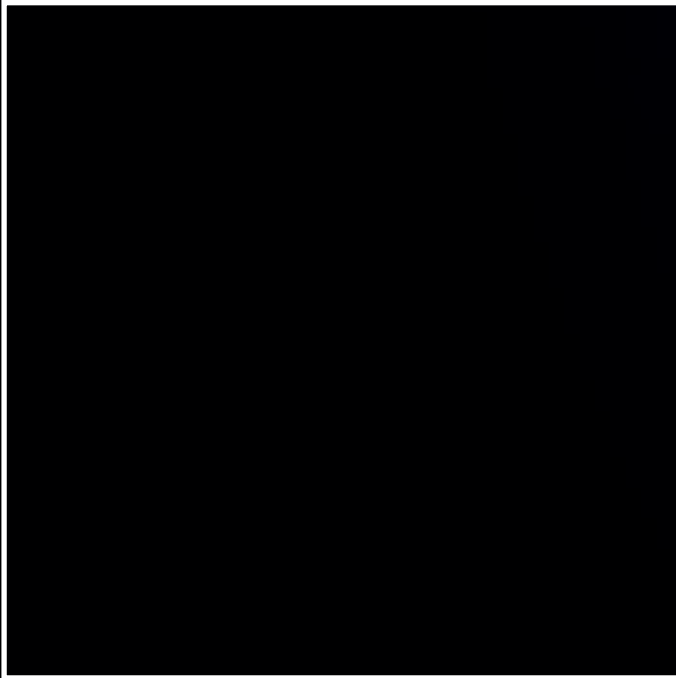

**HERZ d.o.o.**

Grmaška cesta 3  
1275 Šmartno pri Litiji  
T: +386 (0)1 896 21 02  
F: +386 (0)1 896 21 40  
E: [info@herz.si](mailto:info@herz.si)  
W: [www.herz-taps.com](http://www.herz-taps.com)